



Nitrogen fixation in solution

T.A. Bazhenova, A.E. Shilov *

Institute of Chemical Physics, Russian Academy of Sciences, 142432 Chernogolovka, Russia

Received 26 August 1994; revised 13 January 1995

Contents

Abstract	70
1. Introduction	70
2. General considerations	71
2.1. Molecular orbitals of dinitrogen	72
2.2. Thermodynamics of consecutive bond cleavage in dinitrogen	72
2.3. Transition metal complexes: catalysts for dinitrogen reduction	75
2.3.1. Mononuclear complexes	75
2.3.2. Linear binuclear complexes $M-N\equiv N-M$	76
2.3.3. Binuclear complexes of other types	77
2.3.4. Polynuclear complexes M_nN_2 and an optimum catalyst for dinitrogen reduction	78
3. Biological nitrogen fixation	79
3.1. Introduction	79
3.2. Composition and structure of protein components of nitrogenases	79
3.2.1. Fe-protein	79
3.2.2. MoFe-proteins	80
3.3. FeMo-cofactor	81
3.4. Alternative nitrogenases	86
3.5. Functioning of nitrogenase	87
3.5.1. Mechanism of the function of nitrogenase	89
4. Dinitrogen reduction in chemical systems	93
4.1. Aprotic media	93
4.1.1. Stoichiometric systems	93
4.1.2. Catalytic systems	96
4.2. Dinitrogen reduction in protic media	98
4.2.1. Dinitrogen reduction by metal hydroxides	98
4.2.1.1. Mixed vanadium(II)-magnesium(II) hydroxide	99
4.2.2. Soluble complexes of vanadium(II)	101
4.2.2.1. The structure of the vanadium di- <i>tert</i> -butylcatecholate complex	106
4.2.3. Catalytic dinitrogen reduction	107
4.2.3.1. Catalytic dinitrogen reduction by sodium amalgam	108
4.2.3.2. The structure of polynuclear molybdenum complexes	111
4.2.3.3. Dinitrogen reduction in the presence of iron complexes	115
4.2.4. Electrochemical reduction	116

* Corresponding author.

5. Dinitrogen complexes with transition metal compounds and the mechanism of N ₂ reduction in the coordination sphere	117
5.1. Protonation of dinitrogen in mononuclear end-on complexes	119
5.1.1. Protonation and reduction of coordinated dinitrogen	120
5.1.1.1. Kinetics and mechanism of protonation and reduction	123
5.2. Protonation and reduction of dinitrogen in binuclear complexes	125
5.2.1. Complexes [$\{(\eta^3\text{-C}_5\text{H}_5)_2\text{TiR}\}_2\text{N}_2$]	126
5.2.2. Complexes with bivalent titanium and zirconium	127
5.2.3. Binuclear complexes with a single N ₂ molecule, linear MNNM unit, and d ² and d ³ electronic configuration of M	128
5.2.4. Bi- and polynuclear complexes of other types	133
5.2.5. Side-on dinitrogen coordination in titanium complexes	134
5.2.6. Complexes with flat MN ₂ M unit	135
5.2.7. Iron-dinitrogen complexes	137
6. Conclusions	139
Acknowledgments	142
References	142

Abstract

X-ray and other recent data on the nitrogen fixing enzyme, nitrogenase, reveal important details of its structure and provide the opportunity to make plausible conclusions on the mechanism of its functioning. Comparisons with chemical model systems reducing N₂ to hydrazine and ammonia show close similarities to the enzyme systems, in addition to their own peculiarities. The structure of these N₂ complexes with transition metals is discussed in relation to the mechanism of dinitrogen reduction in the metal coordination sphere. This helps in understanding the requirements for a complex to be a catalyst for N₂ reduction in protic media under the action of mild reducing agents.

Keywords: Nitrogen; Nitrogenase; Reduction

1. Introduction

The existence of biological nitrogen fixation by certain bacteria, which has been known since the last century, has inspired chemists to search for purely chemical systems capable of fixing dinitrogen catalytically under mild conditions. Until the 1960s, however, all the attempts to observe dinitrogen reactions at low temperatures and pressures were unsuccessful and the reaction with some metals, mainly lithium, to form nitrides, remained the only example of N₂ reaction at room temperature.

Biological nitrogen fixation was studied in parallel with these attempts by chemists but until the beginning of the 1960s the process was observed only in living bacteria. For a long time, attempts to isolate functioning enzymes, or at least to observe the reaction of N₂ in vitro in the destroyed cells, failed. This of course hampered attempts to investigate the chemistry of N₂ reduction. Even the fact that the primary product is ammonia was frequently put in doubt.

In 1960, dinitrogen reduction in supernatant solution produced from cells was observed for the first time in the presence of the ATP generating system; this work stimulated the development of biochemical investigation of nitrogenase chemistry. The enzyme was isolated rather soon after that and various physical methods were applied by many authors. Since then, progress in understanding the chemistry of the dinitrogen enzymatic fixation has greatly accelerated.

At almost the same time in the early 1960s, the first reactions of dinitrogen in solution were discovered in the presence of transition metal complexes: first in aprotic media with strong reducing agents, and then in water and water–alcohol mixtures with milder reductants. Almost simultaneously, the first dinitrogen complexes with transition metal compounds were discovered and turned out to be unexpectedly very stable. At the beginning of the development of this new field of coordination chemistry, the first metal dinitrogen complexes revealed no chemical reactivity for the coordinated dinitrogen besides the ability of N_2 liberating itself from the coordination sphere. Soon, however, the intermediate complexes with dinitrogen in the coordination sphere capable of further reduction were observed and isolated; subsequently, many dinitrogen complexes were discovered, both mononuclear and binuclear, with N_2 capable of forming hydrazine and/or ammonia upon protonation. These three fields, dinitrogen biological fixation, dinitrogen reduction in solution and dinitrogen complexes with transition metal compounds are clearly closely related and developed in parallel influencing each other. However, for a long time the structure of nitrogenase and the mechanism of its functioning remained obscure, allowing different hypotheses to be tested. Some generalizations can now be made, and it is clear that the enzymatic system is one of a number of systems reducing dinitrogen in protic media that all have something in common, but each having its own peculiarities.

Meanwhile so called FeMo-cofactor was isolated from one of the proteins involved in nitrogenase, apparently playing a central role in the activation and reduction of dinitrogen. Finally, X-ray structures for both Fe- and MoFe-protein, which form the nitrogenase complex, have recently been determined. Although the exact mechanism of dinitrogen reduction is not yet completely clear, there is now much less freedom of choice between possible schemes; with low temperature dinitrogen chemistry already in existence, the next steps in the development of chemical models for enzymatic nitrogen fixation are much clearer than ever before.

2. General considerations

In this section, the properties of the N_2 molecule and the main causes of its chemical inertness will be considered, as well as possible ways of overcoming it. These considerations were developed in parallel with experimental work on biological dinitrogen reduction, dinitrogen complexes and new reactions of dinitrogen in solution. Some of the ideas were suggested before experimental evidence was obtained, others were the result of experimental observation. Not all the conclusions are equally certain, and perhaps some of them are still somewhat speculative.

The inertness of dinitrogen is very well known and reflected in its characteristics

Table 1
Physico-chemical characteristics of the N₂ molecule

Interatomic distance	1.095 Å
Ionization potential	15.058 eV
NN bond dissociation energy	225 kcal mol ⁻¹
Vibration frequency (gas)	2231 cm ⁻¹
Electron affinity	-1.8 eV
Proton affinity	5.12 eV
Solubility:	
in water	1.7×10^{-2} cm ³ cm ⁻³
in benzene	1.11×10^{-1} cm ³ cm ⁻³

(Table 1) [1–3]. N₂ has a very high bond dissociation energy, high ionization potential and negative value of electron affinity. The proton affinity, though positive, is smaller than, for example, methane (5.3 ± 0.3 eV) [2]. Dinitrogen is a very weak base and does not interact even with the strongest acids. The strength of the triple bond does not, by itself, explain the inertness of dinitrogen. The triple bond dissociation energy in acetylene (230 kcal mol⁻¹) is approximately the same as that for dinitrogen, and the carbon monoxide bond energy is even higher (256 kcal mol⁻¹), yet both these molecules undergo multiple chemical reactions unknown for dinitrogen.

2.1. Molecular orbitals of dinitrogen

The electronic configuration of dinitrogen may be represented as $(1\sigma_g)^2(1\sigma_u)^2(2\sigma_g)^2(2\sigma_u)^2(1\pi_u)^4(3\sigma_g)^2$. The highest occupied orbital $3\sigma_g$ is higher than $1\pi_u$ due to the mixing of s- and p-orbitals. Fig. 1 represents the approximate boundary surfaces of the molecular orbitals and their energies. It is seen that the lowest unoccupied molecular orbital $1\pi_g$ is situated rather high, and the two occupied orbitals $3\sigma_g$ and $1\pi_u$ are strongly bonding, their energy differing by 1.5 eV.

2.2. Thermodynamics of consecutive bond cleavage in dinitrogen [4,5]

Important conclusions about the reasons for dinitrogen inertness, as well as clues to overcoming it, may be achieved when considering the energies required for consecutive cleavage of the three bonds in the molecule. Dissociation of the first of the three bonds (requiring more than 100 kcal mol⁻¹) corresponds to about half of the total triple bond energy. It distinguishes this molecule sharply from other molecules with multiple bonds, e.g. acetylene whose first splitting bond energy is the weakest (53 kcal mol⁻¹). The sharp difference between these isoelectronic molecules is evidently a consequence of the repulsion of the two unshared electron pairs and the electron pair of the remaining π -bond after the cleavage of one of the π bonds of dinitrogen, whereas the electron repulsion is less strongly manifested in ethylene since four electrons are involved in two σ bonds with H-atoms in the latter molecule.

This peculiarity of the N₂ molecule is an intrinsic characteristic and does not

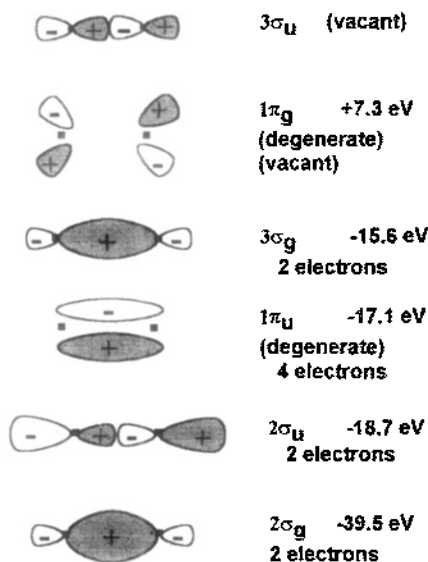
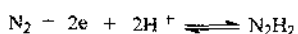
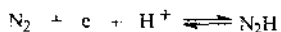

Fig. 1. Approximate boundary surfaces of the molecular orbitals of N₂ and their energies.

reflect the nature of the species reacting with it. Thus the energy of the dinitrogen triplet state (which may be considered as N₂ molecule with one of the π bonds cleaved) corresponds to a much higher level, relative to the ground state, than the corresponding triplet state level of acetylene [6].

The difference in the energy distribution between the bonds in acetylene and dinitrogen leads to drastic differences in the reactivity of these molecules. One- and two-electron reactions which are thermodynamically favorable for acetylenes (and also olefins) are often forbidden for dinitrogen. Thus, hydrogenation of acetylene (as well as ethylene) is strongly exothermic (ΔH_p° for the reaction $C_2H_2 + H_2 \rightarrow C_2H_4$ is $-42 \text{ kcal mol}^{-1}$), whereas the corresponding dinitrogen reaction $N_2 + H_2 \rightarrow N_2H_2$ is strongly endothermic and ΔH_p° is 51 kcal mol^{-1} and 56 kcal mol^{-1} for *trans*- and *cis*-diazene respectively [7]. The addition of the H atom to acetylene is 41 kcal mol^{-1} exothermic, while the reaction $N_2 + H \rightarrow N_2H$ is approx. 9 kcal mol^{-1} endothermic [8]. Therefore, neither a radical chain reaction of dihydrogen with dinitrogen (which could be initiated by the addition of a hydrogen atom to N₂) is possible, nor the catalytic hydrogenation via diazene as an intermediate (and this is one of the reasons for the absence of activity of typical hydrogenation catalysts towards dinitrogen). The formation of ammonia, which is a key process in enzymatic dinitrogen fixation, is N₂ reduction. The strength of the first bond of the N≡N triple bond being cleaved is reflected in the values of redox potentials E_o (Fig. 2) [5]. One- and two-electron transfer with simultaneous addition of protons:



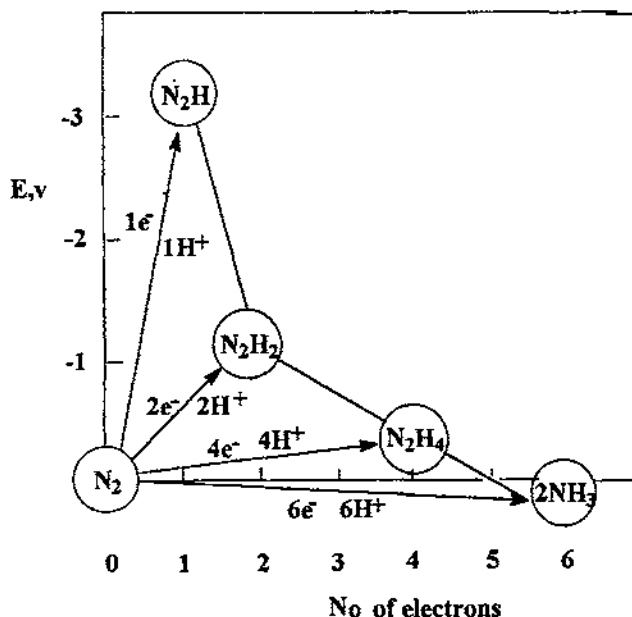
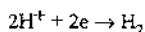

Fig. 2. Redox potential dependence on the number of electrons transferred to N_2 molecule.

correspond to strongly negative values of E_0 , i.e. require stronger reducing agents than dihydrogen.

In aprotic media, strong reducing agents, e.g. lithium metal, are capable of reacting with dinitrogen to form nitrides. These reactions are very unlikely in protic media since the conditions become very favorable for the simpler reaction of dihydrogen formation from two protons:



At the same time, thermodynamic considerations of consecutive bond cleavage in dinitrogen demonstrate its weak points relative to reducing agents. The second and the third bonds that are being cleaved in the molecule are, on the contrary, very weak: about 60 kcal mol^{-1} each [6]. Therefore, the addition of two dihydrogen molecules to dinitrogen forming hydrazine:

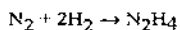

is endothermic to only $20.7 \text{ kcal mol}^{-1}$ in the gas phase and $8.2 \text{ kcal mol}^{-1}$ in water solution, while the addition of three dihydrogen molecules forming ammonia is exothermic (22 kcal mol^{-1} and 38 kcal mol^{-1} NH_3 in gas and water respectively). Thermodynamically, dinitrogen reduction in protic media is facilitated, since the polar molecules formed, i.e. hydrazine and ammonia, are solvated via hydrogen bond formation. Reduction of dinitrogen in water solution to hydrazine and ammonia corresponds to redox potentials of -0.36 V and $+0.55 \text{ V}$ respectively, thus to considerably weaker reductants than for one- and two-electron reduction (Fig. 2).

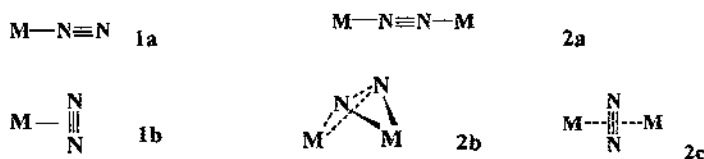

Fig. 3. Modes of dinitrogen bonding.

Therefore, four- and six-electron reduction of dinitrogen gives the opportunity to use comparatively weak reducing agents with the help of a catalyst. The catalyst may consist of a cluster including several metal ions capable of accepting and transferring electrons. If the redox potentials of each one-electron step do not differ much from each other, and are close to the redox potential of the hydrazine or ammonia, the thermodynamic difficulties for dinitrogen reduction will be overcome.

2.3. Transition metal complexes: catalysts for dinitrogen reduction

As has already been mentioned, dinitrogen, similar to other unsaturated molecules, will be able to form complexes with transition metal compounds in which N_2 reveals itself as both an electron donor and acceptor, with the latter properties being much more pronounced. The different kinds of complex already observed experimentally (vide infra), and widely considered theoretically (e.g. see Refs. [9–11]), are presented in Fig. 3. In aprotic media these complexes may react further with a reducing agent to form hydrazides and nitrides, producing hydrazine and ammonia under the subsequent action of an acid. It is important that dinitrogen becomes a much stronger base in these complexes than in the free state, and maybe protonated; this, in turn, strengthens its acceptor properties and facilitates the reduction in protic media. The $d_{\pi} \rightarrow p_{\pi}$ interaction is essential for the reduction of dinitrogen in the coordination sphere of the complexes.

Now consider metal–dinitrogen complexes from the viewpoint of their participation in N_2 reduction. Experimental evidence for the mechanisms considered here, in a general way, will be presented in the following subsections.

2.3.1. Mononuclear complexes

Linear end-on complexes $M-N\equiv N$ are usually more stable than side-on complexes $M \leftarrow \begin{array}{c} N \\ \equiv \\ N \end{array}$ dinitrogen being more activated in linear complexes since metal d-orbitals can interact with both vacant π_g^* orbitals of dinitrogen. Therefore, protonation of dinitrogen and its further reduction in side-on complexes of the type 1b is less likely than in the linear end-on complexes, though the former may be intermediates in the formation of bi- and polynuclear complexes in the reduction process.

Fig. 4 shows the scheme of the interaction of a metal and dinitrogen orbitals in a linear complex 1a. For maximum weakening of the π bonds in dinitrogen, at least four electrons are needed. The reduction of dinitrogen may proceed upon protonation provided it is thermodynamically allowed:

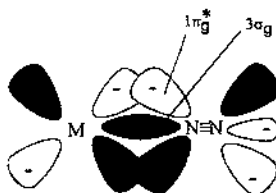
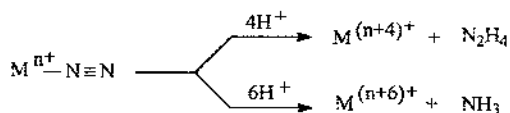

Fig. 4. End-on metal–dinitrogen bonding.



In order to avoid the thermodynamically difficult formation of diazene, N_2H_2 , and to form directly hydrazine or ammonia, the metal ion M has to increase its oxidation state by four or six units respectively. Evidently, this corresponds initially to a very low oxidation state of M , and M must be a sufficiently strong reducing agent. For a catalytic cycle, an even stronger reductant will be needed to return M in its initial reduced state, active towards dinitrogen.

2.3.2. Linear binuclear complexes $\text{M}-\text{N}\equiv\text{N}-\text{M}$

The complexes of the type 2a (Fig. 3) are the most widespread among the binuclear dinitrogen complexes known so far. The mechanism of dinitrogen reduction upon protonation may be presented in the following way:

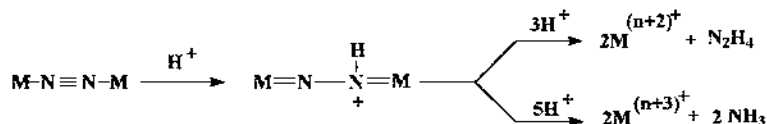

Two electrons from each M interact with two π -orbitals of dinitrogen in this mechanism and, therefore, the cleavage of two π -bonds in N_2 proceeds simultaneously. This mechanism, which allows use of weaker reducing agents than with mononuclear complexes, is a concrete illustration of the four-electron mechanism of N_2 reduction considered above. The complex $\text{M}-\text{N}\equiv\text{N}-\text{M}$ may be represented by the two extreme structures:

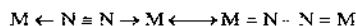

with different weights of each for various M . The structure which might be considered as the product of two-electron reduction of dinitrogen, $\text{M}-\text{N}=\text{N}-\text{M}$, has no physical sense for this process. The reduction of dinitrogen is often considered in the literature as the sequence of two-electron processes, the formation of diazene being facilitated by its coordination on metal complexes. This explanation of the ease of N_2 catalytic reduction is still preferred, even in modern reviews (e.g. see Ref. [12]). Naturally, in the process of protonation, an intermediate $\text{M}_2\text{N}_2\text{H}_2$ will be produced which could formally be regarded as a diazene derivative. However, it is clear that in the proposed mechanism, with both π -bonds affected, and four electrons from two M involved,

the approach with coordinated diazene or its derivatives is an unnecessary formalism; the cleavage of the two π -bonds in the binuclear dinitrogen complexes proceeds simultaneously. Protonation of the dinitrogen ligand will shift the structure approaching the hydrazine derivative. If two M in the binuclear dinitrogen complex each have two electrons available, and are not sufficiently strong reductants to produce hydrazine upon protonation, then participation of an additional external reducing agent providing two electrons may lead to the cleavage of the N–N bond and formation of an ammonia derivative, a precursor of ammonia, which will be formed in hydrolysis, e.g.

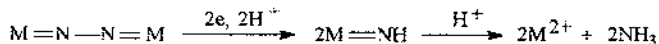

This overall 6-electron process will require a less strong reducing agent than for hydrazine formation.

For a linear binuclear complex $M-N\equiv N-M$, there is an optimum electronic configuration of M for the most effective activation of dinitrogen to reduction through protonation [5]. Considering the molecular orbitals of the binuclear complex [13] it might be expected that the electronic configurations d^2 – d^4 will be most suitable for the catalytic activity of M towards dinitrogen, with the d^3 configuration presumably being optimum. An increase in the number of d-electrons to more than four would lead to the loss of catalytic activity towards dinitrogen.

To improve the catalytic properties of the intermediate complex $M-N\equiv N-M$ (with an appropriate electronic configuration of M) it is important to have a flexible bidentate ligand unifying both Ms and forming a cycle when dinitrogen is coordinated:

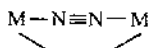

In this case, the coordination of N_2 will be accompanied by a smaller loss in entropy than for two Ms existing separately in solution; this will increase the equilibrium constant of the intermediate complex formation.

2.3.3. Binuclear complexes of other types

Complexes 2b and 2c (Fig. 3) are, as a rule, less stable than 2a. At the same time, they are theoretically feasible [14] and have been observed experimentally. They might be expected to form particularly when:

- (1) both Ms are especially strong electron donors and it is preferable for them to interact with two electronegative N atoms each, rather than with one N; complexes of this kind may be expected for aprotic media;
- (2) both Ms are anchored at a common ligand and are situated at a definite distance insufficient to form a linear complex (the distance between the two metals for such a complex must be approx. 5 Å) but suitable for 2b or 2c (3.5–4 Å); there is no reason why these complexes could not be intermediates in dinitrogen reduction in protic media.

—For complexes 2b and 2c the optimum number of d-electrons at M for the

activation of dinitrogen may be larger than for the linear complexes; in any case the limitation of the number of electrons for these complexes is not evident.

2.3.4. Polynuclear complexes M_nN_2 and an optimum catalyst for dinitrogen reduction

In electron transfer to dinitrogen in a metal- N_2 complex $M-N$, bond formation must compensate for the energy of NN bond loosening. Apparently, the larger the number of metal atoms directly bound to dinitrogen, the easier it is to reach the same extent of NN bond weakening, since each metal provides electrons to the NN bond and, therefore, is already a reductant at the stage of complex formation. Therefore, it might be expected that a three- or even four-nuclear complex like

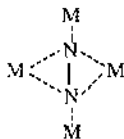

will activate N_2 more effectively than mono- or binuclear complexes. Naturally, metals in these kinds of complex must have special characteristics: coordinative unsaturation must be provided at each M; they have to be situated at definite distances; and their arrangement must be sufficiently flexible for the following N_2 transformation, e.g. to hydrazine.

We can try to visualize an optimum catalyst for dinitrogen reduction in protic media taking into account the above considerations. An optimum catalyst may be defined as one which functions with the weakest, thermodynamically possible reducing agent at a pH close to 7. The enzymatic dinitrogen reduction is presumably close to this definition.

The catalyst is expected to be a polynuclear cluster with maximum number of contacts (e.g. four) with dinitrogen. In its reduced form the catalyst should acquire an appropriate redox potential, not too negative (which would be difficult to achieve) but sufficient to coordinate N_2 and induce its further protonation. Four electrons of the cluster should be available to enter π^* orbitals of dinitrogen. Metal atoms should be bound by a flexible common support to adjust to changes in bond lengths in the process of dinitrogen reduction.

Electrons from an external reducing agent should move to the catalyst together with protons, each proton and electron simultaneously, or immediately after one another, to avoid the accumulation of negative or positive charge which would destabilize the catalyst. Each proton and electron transferred will shift electrons from the cluster to coordinated dinitrogen. At some stage the protonated dinitrogen ligand will be transformed to a hydrazine and ammonia derivative. At this stage, which could be the most difficult, additional electron transfer might be required from the external reducing agent situated close enough to the catalytic site. It is clear that the optimum catalyst must be a highly organized polynuclear molecular system functioning in a concerted way. We shall see that enzymatic dinitrogen reduction fully corresponds to this picture.

3. Biological nitrogen fixation

3.1. Introduction

Biological nitrogen fixation was discovered at the end of the 1880s when Hellriegel and Wilfarth provided clear-cut proof of its existence [15]. Later, it was found that the ability to fixate nitrogen is very widespread among prokaryotes and archeobacteria. It is observed for microorganisms of both anaerobic and aerobic bacteria, free-living and in symbiosis with plants, for example with leguminous plants. The list of reliable diazotrophs includes not less than 200 microorganisms that live almost in any media where life exists [16].

The nitrogen fixing enzyme nitrogenase consists of two proteins, Fe-protein and MoFe-protein. Only in combination do these two proteins perform dinitrogen reduction to ammonia, the key intermediate for subsequent protein synthesis.

3.2. *Composition and structure of protein components of nitrogenases (see reviews in Refs. [16,19,21,22] and references cited therein)*

3.2.1. Fe-protein

Fe-proteins from nitrogenases of different types of microorganisms, as well as from Mo-containing and alternative nitrogenases, have been isolated, purified and thoroughly studied. These proteins have much in common in terms of size, structure and properties. The proteins are dimers of identical subunits with the total molecular mass about 60 kDa. They contain one [4Fe–4S]-cluster that, as shown by recent X-ray structural analysis [19] of single crystals of Fe-protein, binds its subunits using S atoms of cysteines from both subunits as ligands. Amino acid sequences of Fe-proteins of different nitrogenases from more than 20 types of bacteria have been determined and their identity is within 45–90%. Fe-proteins of Mo- and V-nitrogenases of the same microorganism differ the least, for example, for *A. vinelandii* their identity is 90%, but only about 60% identity when the Fe-protein of Fe-nitrogenase is compared with Fe-proteins of Mo- and V-nitrogenases. These data agree well with the data on cross-reactions of proteins: Fe-proteins from Mo- and V-nitrogenases give efficient systems with MoFe- and VFe-proteins, whereas the Fe-protein of Fe-nitrogenase is not efficient in combination with both MoFe- and VFe-proteins [23].

The spectra and redox properties of all Fe-proteins studied are almost the same. This is explained by the existence of a [4Fe–4S]-cluster which functions as a one-electron donor. The method of coordination of the cluster with the protein matrix is identical in all known Fe-proteins, and had been determined even before the three-dimensional structure was obtained by X-ray structural analysis [19]. The parts of the amino acid sequence of enzymes that enter the composition of the active center and, in the case of oligomeric enzymes the part of the protein molecule that performs the protein–protein subunit interactions, are found to be the most conservative. In primary structures of all Fe-proteins studied, four strictly retained residues of cysteine per protein are found. These residues are the most suitable as ligands for binding

the Fe–S-cluster. The consecutive substitution of cysteine residues with serine, by means of the site-directed mutagenesis, helps to establish that only two residues of cysteine, Cys 98 and Cys 133, are essential for the manifestation of the activity of the Fe-protein [24]; (numbering of residues is taken from the Fe-protein of the *A. vinelandii* sequence). It is these residues of cysteine, which belong to different subunits and coordinate the cluster, that makes the binding bridge between them. This structural peculiarity (coordination of metal centers by amino acid residues from different subunits) was observed previously in the photosynthetic reaction centers and nitrate reductase; it was also found in the MoFe-protein of nitrogenases and, probably, it is a common peculiarity of multisubunit metalloproteins [19,22].

In the Fe-protein, the cluster is located virtually on the surface of the protein globules and is easily accessible to solvent. This is likely to be the reason for the strong sensitivity of protein to oxidation, and seems to be necessary for its catalytic action.

The addition of both MgATP and MgADP to Fe-protein causes several effects. The middle-point potential is shifted approximately by 100 mV (from approx. –350 mV to –450 mV), and EPR and circular dichroism spectra change considerably. These effects are usually explained by conformational changes occurring in the protein. The changes are different for the addition of MgATP or MgADP; thus the first facilitates chelation of Fe in the cluster by α,α' -dipyridyl and *o*-phenanthroline, while the second does not reveal this influence [21].

The main function of the Fe-protein in the nitrogenase reaction is in MgATP activated one-electron transfer to the large MoFe-protein, which contains centers of the substrate binding and reduction.

The method of site-directed mutagenesis allows the determination of amino acid residues, which play the principal role in the protein–protein interaction between MoFe-protein and Fe-protein. These turned out to be arginine and glutamic acid [26–28]. They are found in all primary structures of Fe-proteins. X-ray structural analysis of single crystals of Fe-protein shows both of these amino acids to be located on the surface of subunits near the Fe–S-cluster, where the contact of proteins must take place for electron transfer and ATP hydrolysis. When arginine is substituted, for example by histidine, Fe-protein loses its ability to transfer electrons to the MoFe-protein, although it continues to produce the complex with MoFe-protein and catalyzes ATP hydrolysis.

3.2.2. MoFe-proteins

The large protein components of nitrogenase have a molecular mass of about 220 kDa. MoFe-protein is a tetramer of two types of subunits $\alpha_2\beta_2$. Each protein molecule contains two Mo atoms, 32 Fe atoms, and the same number of S atoms in the form of inorganic sulfides. Spectroscopic studies of these proteins, using EPR, ENDOR, Mössbauer, magnetic circular dichroism (MCD), EXAFS, and extrusion techniques and chemical modification, allowed important information about the structure of metal-containing centers in proteins to be obtained. All the transition metal atoms in MoFe-proteins are organized into two types of redox center. About half of the Fe is in the composition of four $[\text{Fe}_4\text{S}_4]$ -clusters, named P-clusters, and

the rest, together with Mo (or V), is in M-centers, also named FeMo (or FeV or Fe-only) -cofactors. P-clusters differ somewhat from the usual ferredoxin-like complexes in a number of physical parameters [22,12].

Primary structures are determined for more than ten MoFe-proteins from free-living (aerobic, anaerobic, photosynthetic) and symbiotic microorganisms for classical and alternative nitrogenases. Considerable similarity is found in amino acid sequences, primary structures and subunits from VFe and FeFe-proteins; these show a greater similarity between each other (55% of identity) than with the MoFe-protein (approx. 32% of identity) [29]. In all MoFe-proteins isolated from different microorganisms, and in analogous proteins of alternative nitrogenases, strictly retained structurally similar domains have been detected around the cysteine residues which are supposed to be the ligands of redox centers in these proteins. Later, this was confirmed by the results of the determination of the molecular structure of the MoFe-protein [18].

Single crystals of MoFe-proteins were obtained long ago, but, for a long time, their molecular structures remained unresolved by X-ray structural analysis owing to difficulties in preparation of isomorphically substituted heavy-atom derivatives of the protein. This problem was first avoided by Bolin, who used an X-ray synchrotron source at several wavelengths. This allowed him to solve the phase problem and determine the three-dimensional structure of the protein with a resolution of 5 Å using the method of anomalous scattering on intrinsic heavy atoms of nitrogenase [30a]. Two cofactors have been shown to be located in two different subunits of proteins ca. 70 Å apart. One large (double) P-cluster containing eight Fe and eight S²⁻ groups is located at a distance of approx. 19 Å from each FeMoco. Apparently, the observed unusual physical parameters of P-clusters are explained by the close spatial arrangement of the two Fe₄S₄-clusters. The electron density pattern indicates the ellipsoidal shape of FeMoco but resolution of 5 Å did not permit conclusions about the mutual arrangement of the Fe, Mo, and S atoms in the cofactor.

In 1992-93 Kim and Rees, with co-authors, published the results of X-ray structural analysis of single crystals of MoFe-proteins from microorganisms of *A. vinelandii* and *C. pasterianum* with resolution of 2.7 Å [18,20,25]. The results of these authors confirmed the data of Bolin concerning a mutual arrangement of metal-containing clusters in proteins. Additionally, it was found that cofactors are located in α -subunits (one per each of two subunits) and immersed at a distance of at least 10 Å from the surface of the protein globule. The surrounding of the cofactor is provided mainly by hydrophilic residues, although there are also some hydrophobic residues.

The total form of the $\alpha_2\beta_2$ -tetramer is such that it can be regarded as an $\alpha\beta$ -dimer with a rotation axis of the second order, which passes through the P-cluster pair located between the α and β subunits. The protein surrounding the P-cluster consists of hydrophobic residues.

3.3. FeMo-cofactor

In 1977, Shah and Brill reported the isolation of the FeMo-cofactor of MoFe-protein [17]. For this purpose they used a procedure which had been successfully

applied for separation of other Mo-cofactors from Mo-containing enzymes: acid-base protein denaturation. The distinction for the MoFe-protein of nitrogenase is that the FeMoco remains bound to denaturated protein, and is separated by extraction with some suitable organic solvent.

The state of the cofactor, whether it was destroyed or not after its separation from protein, is usually estimated by its ability to recover the activity of extracts from cells of mutant microorganisms (with lost ability to synthesize FeMoco) towards acetylene reduction.

Naturally, the cofactor has attracted considerable interest because there is much evidence that it plays a central role in dinitrogen activation and reduction by the enzyme. Besides Mo, the cofactor contains Fe and S. According to the data from various studies, the ratio Mo:Fe:S in the cofactor equals 1:6–8:8–9, all the S exists as sulfide S^{2-} , the molecular mass of the cofactor is approx. 1500 and it is not associated with any amino acid or peptide. Reagents added at isolation were considered as potential ligands of the cofactor. However, it turned out that none of them was absolutely necessary: a number of acids, bases, and solvents in various combinations gave good results at isolation [31,32].

The search for the organic part of the cofactor took almost 10 years. Only in 1988, as the result of development of studies of the biochemical genetics of nitrogenase, was it found that homocitrate is an endogenous ligand of FeMoco and is necessary for its biosynthesis [33].

Sufficiently good resolution obtained by Kim and co-workers studying single crystals of MoFe-protein allowed them to suggest structural models for the cofactor and P-clusters involved in this protein [20a,b,25].

Resolution of 2.7 Å (and later 2.2 Å) does not permit the distinguishing of separate atoms in the cluster. Therefore, the authors used all available information on FeMoco and P-clusters to obtain molecular models: biochemical results on amino acid sequences, substitution of separate amino acids in proteins by site-directed mutagenesis, EXAFS and other spectroscopic results, the data on chemical composition, and the structural data on model complexes. As a result, a convincing picture of the structure of the cofactor and P-clusters was obtained. The structures are presented in Figs. 5 and 6.

The FeMo-cofactor consists of two cubane fragments $[Fe_4S_3]$ and $[Fe_3MoS_3]$ bound by three bridging ligands which are most likely all S (S^{2-}), although one of

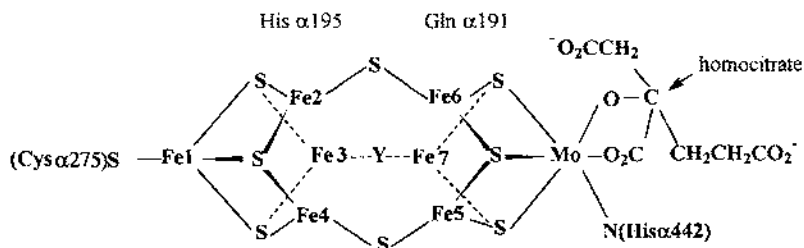

Fig. 5. Proposed FeMo-cofactor structure in nitrogenase MoFe-protein (adapted from Ref. [20]).

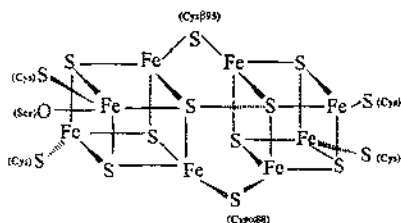

Fig. 6. Structure of P-clusters in the MoFe-protein of nitrogenase (according to Ref. [20]).

them was originally considered a different ligand and was designated Y (e.g. NH or O) [25a]. The three bridging ligands have comparable electron density in MoFe-protein from *C.pasteurianum* [30b], whereas a somewhat lower density was obtained earlier for MoFe-protein crystals from *A.vinelandii* and may reflect dynamical (disorder) properties or compositional heterogeneity of this site [20b]. The cluster is connected with the protein matrix through side groups of cysteine (Cys 275), a ligand of Fe(1) and histidine (His 442), which is a ligand of Mo. These atoms of Fe and Mo are on the third order axis at a distance of 7.5 Å from each other. In this structure, Mo has coordinatively saturated octahedral coordination and is connected, in addition to three S atoms, with nitrogen of histidine and two oxygens of hydroxyl and carboxyl groups of homocitrate. Two more side groups of residues of histidine 195 (His 195) (near Fe(2)) and glutamine 191 (Gln 191) (near Fe(6)) are located in the immediate vicinity of the cluster, but it is unlikely that they are directly connected with metals of the cofactor. The side group of Gln 191 interacts with one of the carboxyl groups of homocitrate. All these amino acid residues (Cys 275, His 442, His 195 and Gln 191) are strictly retained in all primary structures of known MoFe-proteins. In addition, studies by site-directed mutagenesis show that Cys 275 and His 195 are involved in the binding of FeMoco with MoFe-protein in vivo. The substitution of Gln 191 by lysine causes a change in the substrate-reducing properties of nitrogenase [34], and these observations also confirm an assumption that Gln 191 interacts with homocitrate.

The tetrahedral coordination found for Fe(1) and octahedral for Mo are typical of the coordination geometry surrounding these metals, both in model compounds and Fe–S-proteins. The main peculiarity of the suggested model is the fact that six of the seven Fe atoms in the cofactor have an unusual trigonal–pyramidal coordination and are apparently coordinatively unsaturated (the water molecules near Fe, which could be coordinated, apparently having not been found), although the presence of hydride ions in diffraction experiments with such resolution was impossible to determine. The electron density pattern obtained recently by the same authors with a resolution of 2.2 Å for single crystals of MoFe-protein confirms the model suggested previously [25]. The Fe–Fe distances in the cluster are 2.4–2.6 Å, which means the existence of some bonding between Fe atoms apparently additionally stabilizing the cluster. No other atoms are present inside the cluster cavity, whose diameter is approximately 4 Å.

The absence of a large number of bridges binding FeMoco and protein explains

why cofactor can easily be extracted from protein without loss of its catalytic activity when it is reset again on an apo-protein (protein matrix deprived of the cofactor). The immersion of the cofactor inside the protein molecule, when it is bound to protein, explains its stability to water action in the protein-bound state and a rapid decomposition by water in the isolated state. This can be due to the ease with which coordinatively unsaturated Fe atoms undergo an attack of water molecules with subsequent hydrolytic cleavage of the Fe-S-Mo-bridges.

EPR studies of the cofactor isolated from the dithionite-reduced state of the protein show that after separation of protein it retains the characteristic signal with spin 3/2 observed for the M center of MoFe-protein [32]. The broadening of the EPR signal of the isolated FeMoco, when compared with the signal of the M-center, is attributed to a small change in the ligand sphere of the cofactor during isolation. In the MoFe-protein the EPR signal of the M-center has g-factors of 4.3, 3.7 and 2.01. In the isolated FeMoco the appearance of three different types of lines with g-factors of 4.6, 3.4 and 2.0; 4.5, 3.6 and 2.0; and 4.9, 3.1 and 1.9 is observed in addition to the signal broadening. These particles have different pulse voltammetric redox waves at -0.37 V, -0.32 V and -0.43 V respectively [35,36]. This may indicate some uncertainty of the structure of FeMoco in solution and may explain why the cofactor has not been obtained in crystalline form.

The M-center in MoFe-protein is able to exist in at least three oxidation states: dithionite-reduced or semi-reduced (s-r), oxidized (ox), and reduced (red). The dithionite-reduced state of the M-center is obtained through protein purification in the presence of excess dithionite. Such an M-center can be oxidized and reduced. M(s-r) is characterized spectroscopically by an $S = 3/2$ EPR signal. Its oxidation occurs at a potential of -0.05 V in a one-electron process to the M(ox) state by dyes, for example thionine [32]. The M(ox) state is diamagnetic and EPR-silent. M(red)-center is formed during the reduction of M(s-r) in the one-electron process at -0.47 V. This is a substrate-reducing state inside the protein and is achieved only under conditions of the nitrogenase reaction, i.e. in the presence of the complete nitrogenase system: Fe-protein, MgATP, dithionite. This state has an integer spin and produces no EPR spectrum.

Redox processes typical of the protein-bound M-center could also be expected for the isolated FeMoco. The EPR signal of the cofactor is convenient to use as a control of its oxidation state. The same redox-active dyes efficient in the oxidation of M-centers also oxidize the isolated dithionite-reduced FeMoco with the EPR spectrum to the EPR-inactive state. The reaction is entirely reversible with excess dithionite. Dioxygen also oxidizes FeMoco, but in this case irreversibly, even when stoichiometric amounts of O_2 are used, since the addition of excess dithionite can only partially return the initial EPR spectrum with spin 3/2 [31].

Electrochemical studies of the cofactor solution in NMF (2.8×10^{-3} M) have shown that it undergoes a redox transformation, $[ox] \rightarrow [s-r]$ at a formal potential $E_0 = -0.34$ V. The process is only quasi-reversible, anodic and cathodic peaks differing by approx. 100 mV. The EPR spectra of the cofactor were observed in parallel with electrochemical experiments and its solution was titrated with dithionite. The results of this work show that the EPR signal is completely restored after

addition of 0.8 electron per Mo, it follows that a one-electron reduction proceeds in the process [ox]→[s-r]. Additional amounts of dithionite do not affect the EPR signal.

The cyclic voltammogram of the cofactor on a glassy carbon electrode shows, in addition to the FeMoco[ox]→FeMoco[r-s] process, reduction at -1.1 V with the corresponding oxidation at -0.9 V [32]. These waves are ascribed by researchers to the pair FeMoco[s-r]-FeMoco[red]. This is also a one-electron process, because at a relatively fast scanning rate (about 0.4 V s⁻¹) both reductions ([ox]→[s-r] and [s-r]→[red]) are almost equal in current.

The investigation of Mössbauer spectra and the Mo (L-edge) and S (K-edge) XAS spectra of isolated FeMo-cofactor in its three oxidation states indicate that the reducing electron is located on Fe and S atoms and suggest that the Mo atom does not participate in the reduction process [31,32].

The following observation can serve as one of the most convincing proofs that the cofactor is a substrate-binding and a reducing center of the enzyme. The substitution of a single amino acid α -Glu 191 by lysine, or α -His 195 by asparagine, causes two effects simultaneously: the change in the substrate-specificity (both ethylene and ethane are formed from acetylene instead of only ethylene in the native nitrogenase) and the change in the EPR spectrum of FeMoco [34].

Being the catalyst, the cofactor must be able to bind various small molecules. As the addition of a particle must affect its EPR spectrum, EPR spectroscopy was used to demonstrate the reactivity of the cofactor towards different ligands, including substrates of nitrogenase. It was shown that some thiols, selenols, EDTA, *ortho*-phenanthroline and dipyriddy reacted with the cofactor [31,32].

Binding of EDTA to FeMoco causes a complete loss of the EPR signal. The reaction is nonstoichiometric, an approximate 40-fold excess of EDTA is needed. The process is reversible: the addition of stoichiometric amounts of Zn²⁺ completely restores the EPR signal and the activity of the cofactor. *Ortho*-phenanthroline acts in a similar way [36,37], and the addition of Fe²⁺ helps to restore the cofactor activity. It can be concluded that the EPR chromophore is accessible to an exogenic ligand. It is surprising that, unlike synthetic Fe-S-clusters which are rapidly destroyed by chelating agents, the activity of FeMoco is not affected by such reactions.

Thiophenol interacts with FeMoco changing its EPR signal: all three lines narrow and the g-factors shift a little, so the resulting spectrum looks like the spectrum of FeMoco in protein. The stoichiometry of binding is 1:1, Fe being the likely binding center. Selenophenol behaves in a similar way [37]. Citrate binds to FeMoco without a change in the EPR signal somewhere in the external labile coordination sphere. Thus, FeMoco distinguishes between citrate and homocitrate, the latter not binding to FeMoco under similar conditions.

Among the nitrogenase substrates, only cyanide reacts with the cofactor in the dithionite-reduced state [38]. It is directly attached to the cofactor, as indicated by a change in the EPR spectrum. The complete binding is observed at a ratio of 2.4 CN⁻ per Mo. The g-factor values change from 4.6, 3.3 and 2.0 to 4.3, 3.8 and 2.0. The data on titration indicate that each FeMoco binds two CN⁻ ions with different constants. The cyanide and methylisocyanide binding with the cofactor was also

monitored by NMR using the ^{19}F nucleus and $p\text{-CF}_3\text{C}_6\text{H}_4\text{S}^-$ bound to the cofactor as a control ligand. It is shown that Mo does not participate in CN^- (or CH_3NC) binding. Similar NMR experiments show that neither azide-ion nor CO interact with FeMoco in the dithionite-reduced state [31,39].

Attempts to observe the catalytic activity of the isolated cofactor using chemical reductants or in electrochemical reduction have so far failed, and the problem of reducing the cofactor under nonenzymatic conditions and to use it as a catalyst for the substrate reduction remains unresolved. There are promising observations: firstly, the isolated cofactor possesses the redox properties of the M-center of MoFe-protein, and secondly, it reacts directly with an electrode. However, formation of the catalytically active cofactor may not be the result of a simple electron transfer and can require knowledge of how this problem is solved in the enzyme. Perhaps, the isolated FeMoco must be reduced in the presence of some additional ligands, because it is obvious that the protein surrounding the cofactor plays an important role in the nitrogenase catalytic activity. For example, changing even a single amino acid in the region of the strictly retained residue of histidine in the α -subunit of MoFe-protein (His 195), located in close proximity but not directly connected to the cofactor (according to the results of X-ray structural analysis), gives mutants which manifest different properties in reduction of acetylene and dinitrogen, and also in dihydrogen evolution: some demonstrate reduction of acetylene to ethane, others lose the ability to reduce N_2 but continue to reduce acetylene and yield dihydrogen [34,40].

3.4. Alternative nitrogenases (see reviews in Refs. [21,22] and references cited therein)

Mutant microorganisms, which are still diazotrophs even in the absence of Mo in the medium, have been obtained by the change in genes encoding the nitrogenase proteins of *A. vinelandii*. The ability of these microorganisms to fixate nitrogen increased with the addition of V. Isolation of V-containing nitrogenase confirmed the existence of Mo-independent nitrogenases [28]. Subsequently it was shown that a third nitrogenase also existed, which contained neither Mo nor V. It is synthesized by some microorganisms in the absence of Mo and V in the growth medium. Moreover, the addition of Mo or V suppresses nitrogen fixation in strains of microorganisms which have this Fe-only nitrogenase.

The existence of Mo-independent nitrogenases has been established among various nitrogen fixing microorganisms. It turned out that all microorganisms-diazotrophs studied so far have a Mo-dependent nitrogenase system. Some possess only Mo-nitrogenase, while other microorganisms have two or three nitrogenases, some having Mo- and V-nitrogenases and others having Mo- and Fe-nitrogenases.

The composition and properties of three nitrogenases from one bacterial source *A. vinelandii* are summarized in Ref. [21]. All three nitrogenases are composed of two proteins. Each has a specific homodimeric Fe-protein. The second protein component has a different subunit structure in different nitrogenases: MoFe-protein is a tetramer, and VFe- and FeFe-proteins are hexamers. Large proteins of all three nitrogenases contain two types of prosthetic groups, cofactors and P-clusters. FeV-cofactor looks like FeMoco in composition and a number of its physical parameters.

In VFe-protein the chemical environment of V (from EXAFS data) is very similar to that of Mo in MoFe-protein; e.g. similar to Mo, there are no noticeable changes in the ligands nor the oxidation level of V observed in the course of the catalytic cycle [22,41]. The FeV-cofactor can be separated from the protein in a similar manner to FeMo-cofactor. It also contains homocitrate as an endogenous ligand. If the FeV-cofactor is extracted from the VFe-protein and is used for the reconstruction of activity of the apo-MoFe-protein, forming a hybrid protein, the latter, unlike both parents, cannot fix nitrogen but retains the ability of V-nitrogenase to produce ethane from acetylene [22]. These results indicate that interaction of the cofactor with the nearest protein environment seems to be specific in each type of nitrogenase and affects the character of reactions with substrates. All these enzymes have similar requirements for the manifestation of their catalytic activity.

Comparison of the chemical behavior of three nitrogenases shows the following similarities and differences. Mo-nitrogenase can use up to 70% of electrons for the target reaction — ammonia production from dinitrogen; V-nitrogenase uses 40%; and Fe-nitrogenase uses only 20% [21,41]. A similar order is observed for the reaction of acetylene reduction in competition with the reaction of dihydrogen release. Unlike the MoFe-protein, the VFe- and FeFe-proteins give some amount of ethane, a product of the four-electron acetylene reduction, in addition to ethylene, and VFe-protein also produces a small amount of hydrazine (approx. 1%) upon dinitrogen reduction. Similar data for the FeFe-protein are unknown. Apparently, all these data lead to the conclusion that Mo is an optimum heteroatom for the Fe-S-cofactor for the main function of nitrogenase, while less perfect V, and particularly Fe, nitrogenases could be used by microorganisms to fix nitrogen when the concentration of Mo in the environment is insufficient. It should be noted here that a low activity towards reduction of substrates, particularly dinitrogen, of isolated preparations of the Fe-nitrogenase can simply mean that either optimum conditions for the experiments were not found, or something essential is lost in the course of isolation and purification of the enzyme from microorganisms, because experiments with mutant microorganisms *A. vinelandii* containing only the Fe-nitrogenase show that they grow well on N₂.

3.5. Functioning of nitrogenase

Conditions for the performance of the nitrogenase reaction cycle include the presence of MoFe-protein, Fe-protein, MgATP, dithionite and the absence of air or oxygen. Under these conditions dihydrogen evolution occurs with simultaneous hydrolysis of ATP to ADP and phosphate. The introduction of dinitrogen into the atmosphere causes a decrease in the amount of dihydrogen produced and formation of ammonia, whereas the rates of the ATP hydrolysis and the reductant oxidation do not change. Under optimum conditions the main nitrogenase reaction can be presented by the equation:



In addition to dinitrogen reduction, nitrogenase catalyzes the reduction of many

other substrates of small size, mostly with triple bonds. These compounds and the products formed are presented in Table 2.

In the reaction, catalyzed by nitrogenase, hydroxonium ions are reduced to dihydrogen:

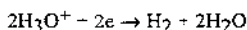

H_2O is considered an endogenous reducible substrate (because nitrogenase functions in an aqueous medium). Dihydrogen evolution by nitrogenase is observed for all microorganisms studied. The conditions for H_2 evolution are the same as for dinitrogen reduction: the presence of ATP, corresponding reductant and nitrogenase. Inhibitors for the reduction of hydroxonium ions are the same as for the nitrogenase reaction. As a rule, these are various chelate-forming compounds. No specific inhibitor of the reduction of H_3O^+ is found. Neither CO , nor H_2 inhibit the reduction of H_3O^+ . Other reducible substrates can be considered inhibitors competing for electrons. The term ATP-dependent for dihydrogen evolution is accepted for the reduction of hydroxonium ion by nitrogenase. This is done to distinguish this reaction from other reactions of hydrogen formation, for example from the reaction catalyzed by hydrogenase. One of the characteristic features of the nitrogenase reaction is the ability to catalyze the formation of HD from H_2O and D_2 only in the presence of N_2 . This reaction is actually not a simple exchange but a reductive hydrolysis of D_2 : it requires electrons to produce HD from D_2 according to the equation:

Table 2

Nitrogenase substrate reactions ([12] and references therein)

Two-electron reductions

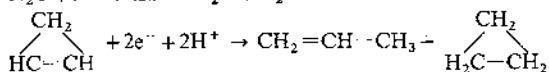
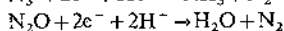
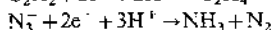
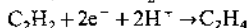
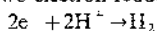

Four-electron reductions

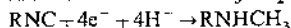
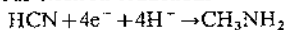

Six-electron reductions

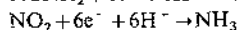
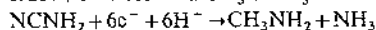
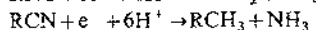
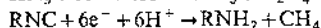
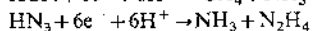
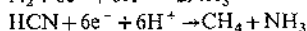
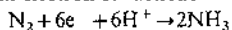

Multielectron reductions

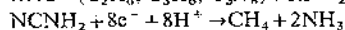
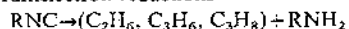

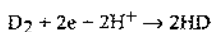

D_2 behaves as a competitive inhibitor of N_2 reduction competing with dinitrogen for electrons.

Of all the substrates of nitrogenase, only acetylene seems to be able to competitively suppress dihydrogen evolution so that under saturation concentrations of acetylene, almost the total flow of reducing equivalents produced by nitrogenase is used for the reduction of acetylene.

3.5.1. Mechanism of the function of nitrogenase

In the process of the nitrogenase catalytic cycle, several reactions proceed consecutively and/or in parallel: formation of the MgATP complex with Fe-protein, reduction of MoFe-protein by this complex, ATP hydrolysis releasing ADP and phosphate, coordination and reduction of a substrate, reduction of Fe-protein, and release of product molecules. The dinitrogen transformation to ammonia is the result of a series of electron and proton transfers. The consequence of electron transfer is established: an external reducing agent, flavodoxine or ferredoxine *in vivo*, or dithionite *in vitro*, transfers its electron to the Fe-protein, then, one by one, from the latter to the MoFe-protein where N_2 is reduced to NH_3 . Presumably, initially electrons go to the P-cluster, then to FeMoco and a substrate. Kinetic and EPR data confirm the oxidation of P-clusters through the electron transfer to FeMoco [42–44]. The three-dimensional structural data show that the Fe- and MoFe-proteins have to interact in such a way that the distance between the centers transferring electrons in succession, Fe-protein \rightarrow P-cluster \rightarrow FeMoco, have to be in the range 12–14 Å. The distance between Fe-protein and FeMoco is 32 Å [20a]; therefore, direct transfer from Fe-protein to the cofactor would be improbable. The rate of Fe-protein oxidation (200 s^{-1}) is in agreement with the theory of electron transfer inside a protein matrix [45].

Kinetic investigation of the nitrogenase reaction indicates that MgATP hydrolysis ($k = 9.4 \text{ s}^{-1}$) precedes the electron transfer inside the complex Fe-protein–MoFe-protein ($k = 3.0 \text{ s}^{-1}$) [42,43]. As already mentioned, MgATP binding provokes a conformation change in the Fe-protein involving the $[\text{Fe}_4\text{S}_4]$ -cluster, and ATP hydrolysis only starts after the Fe-protein–MoFe-protein complex is formed. These observations, together with knowledge of the Fe-protein molecular structure, have led to a hypothesis explaining how the ATP hydrolysis regulates one-way electron transfer to the MoFe-protein [19]. The $[\text{Fe}_4\text{S}_4]$ -cluster and the nucleotide binding centers are far apart, therefore their direct interaction is impossible. ATP hydrolysis results in conformational changes of the Fe-protein, increasing its affinity first to the electron donor (ferredoxine) and then to the acceptor (MoFe-protein). These conformational changes allow the Fe-protein to function as a molecular clock determining the time sequence during the reduction of dinitrogen by nitrogenase. Kinetic investigation of the nitrogenase reaction has led to the conclusion that the electron transfer is accompanied by a cycle of association–dissociation between the Fe- and MoFe-proteins, the dissociation being the rate determining step of the whole process ($k = 5 \text{ s}^{-1}$). However, the dissociation of the proteins is due to the presence of dithionite

which provokes a salt effect [46]; it was shown that photoelectron transfer can be used instead of dithionite with NADH as an electron donor and eosin as photosensitizer. In the absence of dithionite ion the Fe- and MoFe-protein complex seems to be stable facilitating an electron transfer and the reduction of nitrogenase substrates including dinitrogen.

The detailed mechanism of the electron transfer and coupled ATP hydrolysis process remains unclear: such problems as the interaction of the proteins, the electron and protons paths through the proteins, the exact nature of intermediates, etc., remain to be determined. Hopefully, in the near future the situation will change due to new experiments conducted with the knowledge of tridimensional structures of Fe- and MoFe-proteins and molecular models of the M-centers.

A full schematic description of the reactions in the nitrogenase action cycle, based on the experimental kinetic results, was proposed by Thorneley and Lowe. The mechanism involves two reaction cycles, shown in Schemes 1 and 2. Scheme 1 describes the Fe-protein redox cycle of nitrogenase and shows the reactions which proceed on transfer of electrons from the reduced Fe-protein to the MoFe-protein.

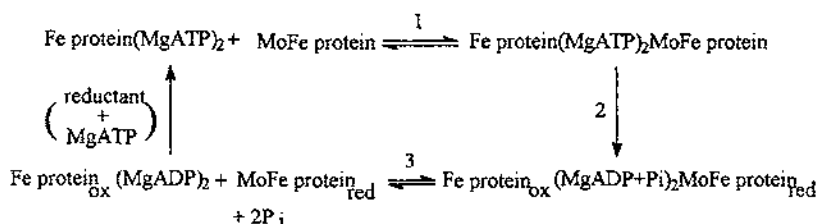

Fig. 7. Scheme 1: the oxidation–reduction cycle of the Fe-protein of nitrogenase [22].

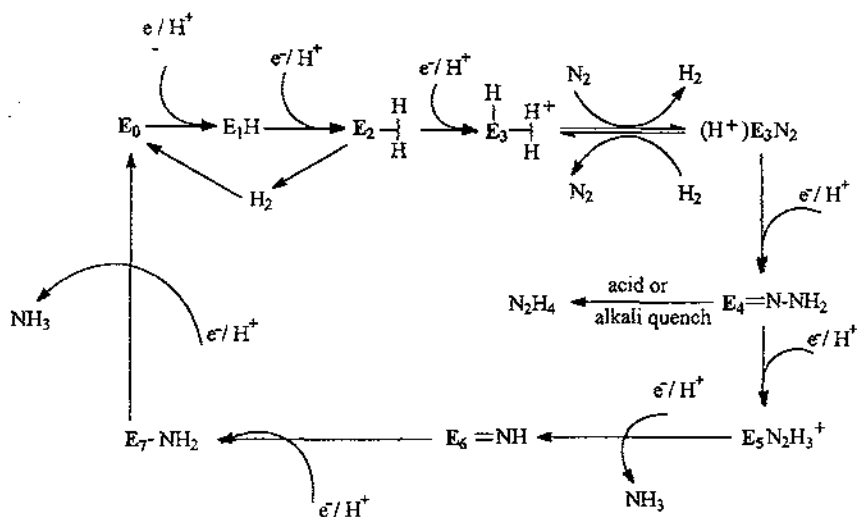

Fig. 8. Scheme 2: the catalytic cycle for the reduction of N_2 by Mo-nitrogenase of *K.pneumoniae*; E_0 , resting state of MoFe-protein, N_2 binds to species E_3 displacing H_2 [22].

As already mentioned, the rate determining step is proposed to be dissociation of the complex of the oxidized Fe-protein and the reduced MoFe-protein.

Scheme 2 presents the changes in the MoFe-protein in the process of electron accumulation in its active center. Here E is MoFe-protein, and the associated subscript corresponds to the number of electrons transferred to it; each step of Scheme 2 is the result of the total cycle 1.

To be able to coordinate and activate dinitrogen, the FeMo-cofactor of the MoFe-protein must be sufficiently reduced: according to the scheme this corresponds to three electrons transferred to the MoFe-protein from the Fe-protein. At step E₃, FeMoco can already reversibly coordinate N₂. Recently, it was experimentally confirmed [37] that the transition from the E₃ state (the reversible binding of N₂) to the E₄ state is connected with the oxidation of the P-centers. This is a critical point of the catalytic cycle of the MoFe-protein; dinitrogen becomes irreversibly reduced to the intermediate state, and corresponds to the hydrazine derivative producing hydrazine when decomposed by acid or alkali. Consecutive addition of two more electrons and two protons leads to the liberation of two molecules of ammonia.

A concrete chemical mechanism for the interaction of dinitrogen with FeMoco is central to understanding the catalytic action of nitrogenase. Before the molecular model of the M-centers was reported, almost all hypothetical mechanisms of a substrate reduction had been based on participation of the Mo atom; the differences in opinion concerning the mechanism were usually connected with the number of Mo atoms (one or two), and with the participation of Fe in the intermediate complex with dinitrogen formed in the process of the reduction (a binuclear MoFe-complex was often proposed).

The discovery of alternative Mo-independent nitrogenases has already led to some doubts about the participation of Mo. The catalytic properties and physical characteristics of the M-centers in these nitrogenases are very similar to each other and to the Mo-containing nitrogenase. Therefore, if dinitrogen can be reduced on the Fe center of the FeFe-cofactor, why should the Fe center not function in Mo- and V-nitrogenases?

Even now, the problem of the detailed mechanism and the site of dinitrogen activation and reduction has not been finally resolved. However, the molecular structure of the cofactor is more suitable for the dinitrogen coordination on the central coordinatively unsaturated Fe atoms than on the coordinatively saturated Mo, rather than forming a mononuclear complex with Mo or a binuclear complex involving both Mo and Fe. The role of Mo (or V in the corresponding V-nitrogenase) might be to stabilize the cluster, and this is revealed in shortening of the Fe-Fe distance at the side close to Mo. Mo in the Mo(IV) (d²) state decreases the number of electrons in the cluster without a serious change of its reducing ability. One might suggest that in an Fe-only cluster the larger number of electrons (if all the Fe atoms are in the Fe(II) state there are four electrons more) is a destabilizing factor (perhaps some antibonding molecular orbitals being occupied). Therefore, there seem to be more similarities between Mo- and V-nitrogenases (presumably V is in the V(III) state with the same number of electrons) than between both these nitrogenases and the Fe-only nitrogenase. The difference between Mo- and V-nitrogenases is due to

somewhat different reducing properties: the reduced VFe-cofactor is probably a stronger reductant than its Mo analog, and, therefore, a small amount of hydrazine is formed in parallel with ammonia in the case of V-nitrogenase; in the case of Mo-containing enzyme, hydrazine is observed only upon the addition of acid or alkali [47], when there is proton or OH^- coaction, and the only final product at neutral pH is ammonia. We shall see in the next section that similar behavior is observed in certain model chemical systems; however, for nitrogenase these suggestions require further experimental evidence.

If activation of N_2 does occur at the central Fe atoms, then the intermediate complex might involve four Fe atoms, and a diagonal arrangement of dinitrogen may be suggested: it will be then coordinated side-on to two Fe atoms and end-on to the other two. Other possibilities for coordination of dinitrogen to the cofactor have been proposed from X-ray structural data (Orme-Johnson [48], Hoffmann [49], Kim and Rees [25]), including N_2 coordination with one and two Fe atoms. They are not necessarily alternatives for a single step of dinitrogen activation on the cofactor, since the number of contacts may increase with time if the coordination is actually a multi-step process, e.g. N_2 might start to coordinate first to one Fe atom and then include other atoms of the reaction center. We prefer diagonal four-coordinated N_2 for activation because both end-on and side-on binuclear dinitrogen complexes are known. There are few examples of three-nuclear complexes, and some indirect evidence indicates the existence of four-nuclear ones (*vide infra*). Four contacts will strongly activate dinitrogen and facilitate the subsequent formation of a hydrazine derivative. At the same time, the involvement of all six central Fe atoms of the cofactor in the activation suggested by Kim and Rees [25] seem less probable: firstly, Fe–N distances inside the Fe_6 trigonal prism [49] are too short; secondly, there is some evidence that a hydrazine derivative is formed as an intermediate in enzymatic N_2 reduction, and even some free N_2H_4 is produced in parallel with NH_3 on V-nitrogenase. The involvement of six atoms would probably have produced only ammonia. However, the remaining two Fe atoms may take part in the process in the later stages, e.g. in cleavage of the N–N bond. The scheme shown in Fig. 9 is suggested for the activation and reduction of dinitrogen on the cofactor.

Coordination of N_2 to form complex 2 from 1 may induce another electron transfer and lead to a more reduced center(3) (without N_2 , dihydrogen is produced in reaction of complex 1 with solvent protons). Complex 3 may react with D_2 to form a dideuteride and then 2HD in the process of hydrolysis; this step can explain the requirement of N_2 to observe HD formation without involvement of coordinated diazene which was postulated. Complex 3 in the scheme corresponds to the state E_3 in the catalytic cycle of the Thornley-Lowe scheme, in which N_2 is still reversibly bound to the cofactor; the next step is the irreversible four-electron reduction to the hydrazine derivative (state E_4 in the Thornley-Lowe scheme), which requires one more electron and is accompanied by an electron transfer from the P-cluster. The mechanism of N_2 reduction proposed here, although tentative, already has some analogies with chemical dinitrogen reduction in the presence of transition metal complexes.

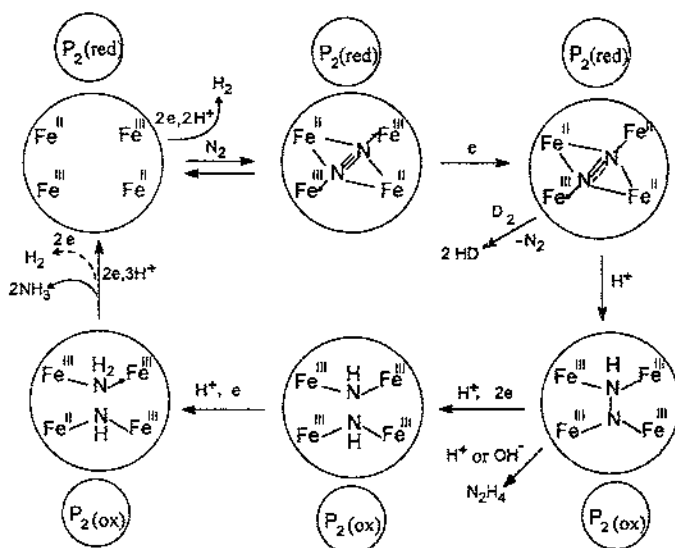
POSSIBLE DYNAMICS OF N₂ ENZYMATIC REDUCTIONFig. 9. Possible dynamics of N₂ enzymatic reduction.

4. Dinitrogen reduction in chemical systems

4.1. Aprotic media

4.1.1. Stoichiometric systems

Biological nitrogen fixation involves a donor of electrons (ferredoxin *in vivo*, or dithionite *in vitro*), the system of electron transfer and the site of dinitrogen activation where the N₂ molecule is bound to a transition metal complex and is subsequently reduced to ammonia with participation of protons. As we have seen, this site, presumably an FeMo-cofactor, is a very sophisticated, well organized molecular system necessary for dinitrogen reduction by a comparatively weak reducing agent. If the reducing agent is sufficiently strong, the system for N₂ activation need not be so well organized. In aprotic media we can use very strong reducing agents to form nitrides from intermediate dinitrogen complexes, and then produce ammonia upon the subsequent addition of an acid.

This was discovered in 1964 by Vol'pin and Shur who published their pioneering paper [50] describing the results of dinitrogen reduction in aprotic media. The reaction turned out to be quite general. The Vol'pin and Shur report initiated a new stage in dinitrogen studies in solution which had previously been virtually unexplored.

In the first experiments [50] transition metal chlorides were used (CrCl₃, MoCl₅, WCl₆, FeCl₃, TiCl₄) reacting with strong reducing agents, such as LiAlH₄, EtMgBr or *i*-Bu₃Al. Ammonia was produced in the hydrolysis of the reaction products.

Appreciable yields of the reaction product (up to 25% of ammonia relative to the amount of transition metal employed) were observed at comparatively high dinitrogen pressure (100–150 atm). Later Vol'pin and his co-workers succeeded in obtaining more active systems. Thus, in the reaction of N_2 with the products of the reaction of Cp_2TiCl_2 ($Cp \equiv \eta^5-C_5H_5$) with $EtMgBr$ in ether, the yield of ammonia (after hydrolysis) was 67% mol^{-1} of titanium compound employed, even at atmospheric pressure [51]. On increasing the pressure, the yield of ammonia became nearly quantitative. In the search for new nitrogen fixing systems, the number of transition metal compounds and possible reducing agents were greatly enlarged by Vol'pin's team and the many other investigators who joined this field of research (see the reviews in Refs. [52–55] and the references cited therein).

Typical examples of nitrogen-fixing systems are presented in Table 3. The activity of the systems towards dinitrogen varies widely, depending on the systems and reaction conditions. However, some generalizations can be made. First, the number of transition metal compounds capable of taking part in the nitrogen-fixing systems is very large. Aside from those already mentioned, vanadium, manganese, and cobalt chlorides, tetraalkoxy-derivatives of titanium, acetylacetonates of vanadium, chromium, molybdenum, manganese and nickel, cyclopentadienyl derivatives of zirconium and niobium, and triphenyl phosphine complexes of titanium and iron proved

Table 3
Dinitrogen reduction in aprotic media

System (and the ratio of reagents)	Solvent	$P(N_2)$ (atm)	Time (h)	NH_3 yield per mole of M^*
$TiCl_4 + i-Bu_3Al$ (1:3)	<i>n</i> -heptane	150	11	0.25
$TiCl_4 + Ph_2^- Na^+$	THF	80	6	1.2
$Cp_2TiCl_2 + EtMgBr$ (1:9)	Et_2O	1	9	0.67
$Cp_2TiCl_2 + Mg + MgBr_2$ (1:14:5)	Et_2O/C_6H_6	100	7	1.3
$VO(acac) + n-BuLi$ (1:9)	<i>n</i> -heptane	75	10	0.32
$FeCl_3 + EtMgBr$ (1:9)	Et_2O	150	18	0.09
$FeCl_3 + Napht^{2-} 2Li^+$ (1:8)	THF	110	4	1
$ZrCl_4 + Ph_2^- Na^+$ (1:6)	THF	80	6	0.5
$MoCl_5 + Mg + MgI_2$ (1:14:5)	Et_2O/C_6H_6	100	7	0.36
$Cp_2Yb + Napht^- Na^+$ (1:10)	THF	1	2	0.23
$Cp_3Sm + Napht^- Na^+$ (1:10)	THF	1	24	0.14

to be active. Later, lanthanide compounds were included in the list of nitrogen-fixing systems, the most effective being the compounds of samarium and ytterbium [56]. The strongest N_2 reducing capacity is displayed by transition metals of Groups IV, V and VI of the Periodic Table, e.g. Ti, V, Cr, Mo and W; particularly active are titanium compounds. In the first row of transition metals, the ammonia yields decrease generally from left to right, in line with decreasing stability of the nitrides. However, iron compounds are, as a rule, more efficient than manganese compounds. Cobalt and nickel compounds are usually of low or no activity. Palladium, copper and platinum complexes apparently demonstrate no activity in any system tested.

Yields of ammonia strongly depend on the reducing agent. The reductants include organometallic compounds ($RMgX$, RLi , R_3Al), metal hydrides ($LiAlH_4$, LiH), free metals (alkali, alkaline earth, rare earth), aromatic radical anions and dianions, and dihydrogen (in combination with other reductants). The function of a reducing agent is to produce a low-valent transition metal complex activating dinitrogen. Usually, for stronger reducing agents the yields of ammonia are higher: $FeCl_3$ produces only approx. 9% yield of ammonia per Fe in the presence of $EtMgBr$, whereas under the action of such a powerful reducing agent as dilithium naphthalene the yield of ammonia (after hydrolysis) reaches 100% [56]. Cp_2TiCl_2 forms extremely active systems with $EtMgBr$ but does not reduce N_2 in the presence of $i-Bu_3Al$. The reason is, apparently, the inability of the later reductant to reduce titanocene to a lower oxidation state than $Ti(III)$, while at least bivalent titanium is needed to activate and reduce dinitrogen. Usually, the yields of ammonia (after hydrolysis) vary from less than 0.01–1 mol per mole of transition metal complex, indicating that two transition metal atoms are likely to participate in the reduction of one dinitrogen molecule, though in some systems (particularly with very strong reducing agents) up to 2 mol of ammonia are produced per mole of the complex.

The Vol'pin and Shur systems are, of course, very far from biological dinitrogen reduction, primarily being much stronger reductants. Nevertheless, there are some similarities, e.g. carbon monoxide and acetylenes are strong inhibitors of N_2 reduction in the chemical systems, similar to their behavior in the enzymatic process. It is significant that, although water cannot be used as a solvent in the presence of such strong reducing agents, Lewis bases (ether or tetrahydrofurane) do not inhibit dinitrogen reduction, i.e. dinitrogen can successfully compete with the bases for a coordination site in low-valent transition metal complexes.

As mentioned above, complex nitrides are usually the main products in the dinitrogen reducing systems in aprotic media, though their exact nature remains mostly unknown, because of difficulties in isolation.

Some of the Vol'pin–Shur systems produce aromatic amines on hydrolysis of the reaction mixture [60]. For example, aniline, as well as NH_3 , is present in the hydrolysis products of $Cp_2TiCl_2-LiPh-N_2$ or $Cp_2TiPh_2-LiPh-N_2$ in ether. Formation of N–C bonds in the reactions with aryllithiums evidently occurs in the nucleophilic attack on coordinated dinitrogen.

Hydrazine, the product of partial N_2 reduction, was detected in chemical dinitrogen reducing systems before it was found in biological systems. First reports on N_2H_4 as the product of N_2 reduction appeared in 1969. In one paper [61], the formation

of an unstable N_2 complex with low-valent Ti was reported in the system Cp_2TiCl_2 - i -PrMgCl- N_2 at low temperature in equilibrium with free dinitrogen (vide infra). At $-60^\circ C$ N_2 in the complex is slowly reduced to a product which can be hydrolyzed to N_2H_4 . The yields of hydrazine over several hours correspond to the amount of coordinated N_2 measured at lower temperature ($-100^\circ C$), where the complexation is virtually complete. No nitride is formed at $-60^\circ C$, but further reduction to nitride occurs with excess of i -PrMgCl at temperatures above $0^\circ C$ [62].

In another system, $Ti(Oi-Pr)_4$ - $NaNp$ - N_2 , hydrazine was also found in the hydrolysis products [63]. Later, hydrazine was detected in a number of other systems, including the systems based on Ti, Mo, Fe, etc. [64] (vide infra).

4.1.2. Catalytic systems

Attempts have been made to design systems for the catalytic hydrogenation of N_2 . However, dihydrogen usually inhibits the reaction, decreasing the yield of NH_3 even in systems that normally catalyze hydrogenation of unsaturated compounds. In some cases, H_2 does not affect the yield of NH_3 , and in a few cases, for example $Ti(OEt)_4 + (i-Bu)_3Al + N_2$, an appreciable increase in the yield of ammonia (after hydrolysis) was observed following the introduction of H_2 . However, with increase of dihydrogen pressure, the yield of ammonia passes through a maximum which is still less than 100% with respect to the titanium compound chosen, and then falls. Nevertheless, these systems demonstrate the possibility for participation of dihydrogen (perhaps forming hydrides and subsequently some N-H containing compounds in the process of reduction). Indeed, there is some evidence that N-D bonds are present in products in systems when deuterium is replaced for dihydrogen.

Although in none of the instances was catalytic hydrogenation observed, Vol'pin and co-workers achieved the catalytic reduction of dinitrogen under the influence of a more powerful reducing agent. They found that aluminum metal reduces dinitrogen at $130^\circ C$ and a pressure of 100 atm in the presence of titanium tetrachloride and aluminum bromide.

Lithium aluminum hydride can be used as a reducing agent instead of aluminum in catalytic systems. In the case of the catalytic system $TiCl_4 + LiAlH_4 + AlBr_3$ more than 100 mol of ammonia (after hydrolysis) per mole of initial titanium tetrachloride can be obtained even at 60 – $70^\circ C$ when the reaction is performed in a molten mixture of aluminum chloride and bromide. When the triple mixture $AlCl_3$ - $AlBr_3$ - C_6H_6 is used as a solvent, some catalytic reduction of ammonia can be observed (NH_3 :Ti is approx. 5) even at $30^\circ C$.

Although, so far, catalytic hydrogenation of dinitrogen has not been observed in aprotic solutions, Japanese workers have shown that the introduction of alkali metals strongly activates the heterogeneous catalysis of the synthesis of ammonia from dinitrogen and dihydrogen. Thus, Tamaru et al. observed that the reaction of iron, cobalt, titanium and molybdenum phthalocyanine complexes with metallic sodium resulted in the formation of a donor-acceptor complex which can catalyze the synthesis of ammonia from dinitrogen and dihydrogen starting from temperatures as low as $110^\circ C$. Ozaki, Aika and Hori showed that alkali metals sharply increase the catalytic activity of ruthenium, osmium, iron, molybdenum and other metals in

the synthesis of ammonia; ruthenium activated by potassium is capable of catalyzing the reaction at 146 °C and atmospheric pressure. (For a review see Ref. [58].)

Another approach to preparation of catalysts for ammonia synthesis from dinitrogen and dihydrogen was the use of systems based on lamellar graphite compounds (LGCs) with transition metals and their chlorides, as well as systems prepared from the potassium salts of transition metal carbonyl hydrides supported on activated carbon [55-59]. In both cases, potassium metal was used to activate the systems to the catalysis of ammonia production (in the latter system after thermal decomposition of the carbonyl hydrides). LGCs with Fe form active catalysts only in the presence of potassium metal. The presence of potassium is also essential for the catalysis of the isotope exchange $^{28}\text{N}_2 + ^{30}\text{N}_2 \rightarrow 2^{29}\text{N}_2$. The most active systems, both for isotope exchange and ammonia synthesis, are based on OsCl_3 and RuCl_3 (the reaction was observed at 250 °C). For FeCl_3 , the exchange starts only at a temperature higher than 350 °C. The most active systems were obtained with $\text{K}_2\text{Fe}_2(\text{CO})_8 + \text{K}$ and with $\text{K}_2\text{Ru}_4(\text{CO})_{13} + \text{K}$ on activated carbon. The former system catalyzes the ammonia synthesis even at 150 °C and atmospheric pressure; at 250 °C its activity is 2.5 times higher than that of the classical industrial ammonia synthesis catalyst. The catalyst can work in a two-step manner. If the catalyst prepared from $\text{K}_2\text{Fe}_2(\text{CO})_8 + \text{K}$ at the activated carbon is heated first in a N_2 atmosphere at 250 °C and then dinitrogen is removed and replaced with dihydrogen, and the catalyst is kept at the same temperature, the ammonia is produced in 0.4-0.5 mol yield per mole of Fe. Hydrolysis of the catalyst after its reaction with N_2 at 250 °C also produces ammonia. These results indicate that surface nitrides are formed in the reaction of Fe (produced in the decomposition of the carbonyl hydride) with dinitrogen at 250 °C, and potassium is essential in this reaction. Therefore, Fe evidently forms a complex with N_2 which is reduced to nitride with participation of potassium, and the nitride can be transformed to ammonia in the reaction with dihydrogen or with protons in the hydrolysis. In the presence of dihydrogen, formation of the surface intermediate, which can subsequently be transformed to ammonia in reaction with dihydrogen, is faster than the reaction of pure dinitrogen to form nitrides. Therefore, dihydrogen presumably takes part in the reduction together with potassium, perhaps producing surface amides or imides.

There is a clear similarity of these reactions with the classical ammonia synthesis on the industrial Fe catalyst, and, at the same time, with some dinitrogen reactions in aprotic media (particularly with those facilitated in the presence of dihydrogen) but also in some aspects with the enzymatic dinitrogen reduction [60]. In all cases, polynuclear Fe forms the active center and can produce ammonia reacting with N_2 via intermediates involving Fe-nitrogen bonds. The main difference from the natural process is the requirement for a much stronger reducing agent (potassium), and/or much harsher conditions (higher temperatures and pressures). Thus, acid, which produces ammonia from metal nitrides (or N-H containing intermediates such as amides or imides), simultaneously decomposes the catalytic system. To bring the chemical systems nearer to the enzyme one, there is a need to use less strong reductants that are stable enough in protic media to continue functioning after ammonia is produced. As indicated, better organized systems are necessary in order to fulfill this goal [64].

4.2. Dinitrogen reduction in protic media [52,65–68]

The first reproducible results demonstrating effective dinitrogen reduction with participation of protons were obtained in 1970 [69].

Dinitrogen was first reduced by freshly prepared hydroxides exerting strong reducing ability and containing Mo or V. The use of hydroxides was not planned, but this observation was in full agreement with theoretical expectations. In strongly alkaline media hydroxides greatly increase their reducing properties and involve several metal ions in close proximity to perform four- or six-electron dinitrogen reduction. Later, some other systems were found (Table 4). The number of metal compounds capable of reducing dinitrogen in protic solvents is much smaller than the number of N_2 -reducing systems in aprotic media. This is due to an additional restriction: to reduce N_2 in the presence of active protons a system still has to be a sufficiently strong reductant but must not react easily with the solvent, e.g. producing H_2 .

4.2.1. Dinitrogen reduction by metal hydroxides

Mo(III) and V(II) hydroxides turned out to be most active; in the case of Mo(III) in the presence of stronger reducing agents, and for V(II) hydroxide with excess $Mg(OH)_2$. Later, other hydroxides were added to this list. They include $Ti(OH)_2$, $Nb(OH)_3$ and $Ta(OH)_3$, and all combine negative redox potentials with a d^2 or d^3

Table 4
Systems reducing dinitrogen in protic media

M	Reducing agent	Products	Yield ^a	Conditions ^b
Ti ^{III}	Na(Hg)	N_2H_4 , NH_3	0.01	20
Mo ^{III}	$Ti(OH)_3$	N_2H_4 , NH_3	1	60
	$Ti(OH)_3 + Mg(OH)_2$ (without Mo)	N_2H_4 , NH_3	170	110
	$Cr(OH)_2$ (without Mo)	N_2H_4 , NH_3	0.005	180
	$Cr(OH)_2$ (without Mo)	N_2H_4 , NH_3	0.80	90
	$Na(Hg) + Mg^{2+}$	N_2H_4	0.015	90
	$Na(Hg) + Mg^{2+} + PC^c + R_3P$	N_2H_4	2.5	20
	$Na(Hg) + Mg^{2+} + PC^c + R_3P$	N_2H_4	10,000	20
V ^{II}	Cathode + $Ti(OH)_3$	N_2H_4 , NH_3	0.5	20
	$V(OH)_2 + Mg(OH)_2$	N_2H_4 , NH_3	0.65	20, water, pH 14.3
	$V^{II} + catechol$	NH_3	0.35	20, water, pH 12
	$V^{II} + catechol$	NH_3	0.75	20, water, pH 10.5
Nb ^{III}	$Nb(OH)_3$	N_2H_4 , NH_3	0.09	35
Ta ^{III}	$Ta(OH)_3$	N_2H_4	0.02	35

^a Moles per mole Mo or Ti for systems with Mo and Ti; current yield for electrochemical reduction; for other systems according to the stoichiometry $4Red + 4H^+ + N_2 \rightarrow N_2H_4 + 4O_x$.

^b Medium: aq. methanol unless otherwise stated; pressure: ca. 100 atm N_2 ; all temperatures in Celsius.

^c PC: phosphatidylcholine.

electronic configuration. $\text{Ti}(\text{OH})_3$ (d^1) is inactive, while $\text{Cr}(\text{OH})_2$ (d^4) is only weakly active. In all cases, they reduce dinitrogen to hydrazine and/or ammonia when freshly prepared under N_2 by additions of alkali to the corresponding salt in water or alcohol solution. They lose this activity on standing; some, e.g. $\text{V}(\text{OH})_2$ (without $\text{Mg}(\text{OH})_2$) and $\text{Ta}(\text{OH})_3$ do so very quickly, but others, like $\text{V}(\text{OH})_2\text{--Mg}(\text{OH})_2$ and $\text{Nb}(\text{OH})_3$ keep their activity much longer. Each of the systems has its own peculiarity, but they have much in common. The optimum reaction media for almost all the systems is aqueous methanol (2–10% H_2O). It is more effective than water alone, firstly because of the higher solubility of dinitrogen, and secondly, perhaps, because the hydroxides containing methanol and methylate as ligands preserve their amorphous character longer until undergoing transformation to a stable and rigid hydroxide structure that was found to be inactive towards dinitrogen. In alcohols with longer alkyl chains, the yields are generally decreased, probably because low dielectric constants disfavor the formation of polar products from dinitrogen (see Section 2.2).

High alkaline concentration (1 M and higher) first leads to N_2H_4 formation, which can further be reduced to ammonia. At lower alkaline concentrations (pH 8–12) the reaction rate is generally much slower, and the only product is ammonia, which is produced directly from dinitrogen without free hydrazine as an intermediate. This important fact, which resembles ammonia formation in the enzymatic reaction (where hydrazine is a poor substrate), follows from kinetic measurements of dinitrogen and hydrazine reduction; hydrazine is reduced too slowly to be the intermediate and special experiments with $^{15}\text{N}_2$ confirmed this conclusion. In the intermediate range, hydrazine and ammonia are produced in parallel.

Dihydrogen is formed in all dinitrogen reducing systems, and this reaction, competing with N_2 reduction, is one of the factors decreasing reaction yields. Carbon monoxide inhibits dinitrogen reduction. Acetylene is reduced in all systems which reduce N_2 , but the range of C_2H_2 reduction is much broader; acetylene is reduced by both $\text{Cr}(\text{OH})_2$ and $\text{Ti}(\text{OH})_3$ formed without Mo, as well as by $\text{Mo}(\text{OH})_3$ alone, i.e. in the systems inactive or poorly active towards N_2 . Moreover, it has long been established that Cr^{2+} ions reduce acetylene in homogeneous acid solutions in the reaction

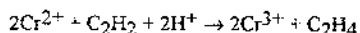

An intermediate complex was detected upon cooling solutions of Cr^{2+} with acetylene. The complex contains two chromium ions per acetylene molecule [70a,b].

In the case of the hydroxides, ethane is formed together with ethylene, C_2H_6 being produced directly from acetylene and not from free ethylene formed intermediately. This four-electron reduction is again analogous to enzymatic acetylene reduction in the presence of two alternative nitrogenases, V and Fe only enzymes.

4.2.1.1. Mixed vanadium(II)–magnesium(II) hydroxide [65a]. This will be considered as an example in rather more detail. It remains one of the simplest and most active dinitrogen reducing systems. The reduction of N_2 occurs in aqueous or alcohol suspensions of freshly prepared hydroxide formed by adding excess alkali to a solution of a mixture of VCl_2 and MgCl_2 . Apparently, $\text{V}(\text{II})$ (d^3) in the mixed

hydroxide combines the ability to both activate and reduce dinitrogen. The reaction produces hydrazine and ammonia at high rates at room and lower temperatures and at atmospheric N_2 pressure. Dinitrogen fixation takes place even from air, dioxygen only somewhat diminishing the yield.

At high concentrations of alkali and high dinitrogen pressures the reaction ends up with hydrazine formation according to the stoichiometry

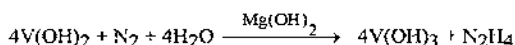

The hydrazine formed competes with dinitrogen for electrons of V(II), particularly at low N_2 pressures, and ammonia can be the final product. The highest yields of hydrazine and ammonia reach approx. 65% per vanadium electrons.

At low alkali concentrations (pH 8–12) as, already mentioned, ammonia is directly produced from dinitrogen without intermediate formation of free hydrazine; thus the reaction

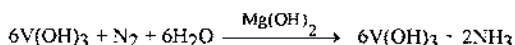

takes place.

The role of excess $Mg(OH)_2$ appears to be prevention of formation of a rigid structure of $V(OH)_2$ which is inactive towards N_2 . In the absence of $Mg(OH)_2$, vanadium(II) hydroxide is active only in first few seconds after its formation and quickly loses its activity. In the presence of excess magnesium hydroxide ($[Mg]:[V] > 10$), hydroxovanadium species form polynuclear clusters which are reasonably stable and only slowly lose their activity towards N_2 . In turn, V ions in the mixed hydroxide prevent the crystallization of $Mg(OH)_2$ and the system remains amorphous for a long time. Some indirect evidence [65a] indicates the number of V ions in the clusters to be equal to four or six, though it is not excluded that there is a distribution of cluster sizes with some variation in the number of V ions from one cluster to another.

Some of the V ions in the clusters are likely to be separated from each other by the bridges involving magnesium ions. Therefore, linear binuclear VNNV complexes can be suggested as intermediates in N_2 reduction, which have to correspond to a high level of dinitrogen activation; the following scheme for the reaction mechanism may be suggested:

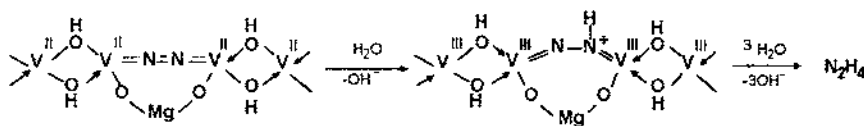

The structure of the intermediate N_2 complex was proposed [70c] on the grounds of general consideration (see Section 2.3.4). Now there is some confirmation of the possibility of this structure. Binuclear V(II) complexes with a linear $V \equiv N \equiv N \equiv V$ fragment were prepared, both open and cyclic, the latter particularly resembling the postulated intermediate (see Section 5.2.3). Magnesium ion bridges were confirmed for Mo complexes (see Section 4.2.3).

The system may be considered as a quasi-homogeneous solution of polynuclear V(II) complexes, and usual kinetic analysis may be applied [70c]. The reaction is diffusion controlled at room temperature (the rate is determined by N₂ diffusion through magnesium hydroxide to the reaction center), but at 10 °C and lower the reaction is sufficiently slow that the reduction process becomes the rate determining step. The dependence of the rate constant on the dinitrogen pressure shows some curvature, indicating the approach to saturation. The following simple scheme may be suggested to interpret the kinetic results:

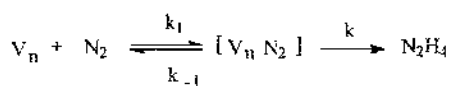

This scheme leads to the well-known Michaelis–Menten equation:

$$v = k[V_n]_0[N_2]/(K_m + [N_2])$$

where $[V_n]_0$ is the initial concentration of active centers, K_m is the Michaelis constant equal to $K^{-1} + k/k_1$ and K is the equilibrium constant of the dinitrogen complex formation with V_n .

If $K^{-1} \gg k/k_1$, which is likely to be the case, both the equilibrium constant K and the rate constant k of the intermediate complex reaction can be determined from the slope of the plots of V^{-1} vs. $[N_2]^{-1}$ which should be linear. Accordingly, the plots are linear, and from their temperature dependencies, the values of both the enthalpy ΔH_r for complex formation and the activation energy E for the complex reaction to form hydrazine were evaluated. They are: $\Delta H_r = -4 \text{ kcal mol}^{-1}$ and $E = 8.4 \text{ kcal mol}^{-1}$. Both values are very low, even among systems reducing N₂ in protic media, and correspond to the intermediate complex low stability and high reactivity.

Mixed V(II)–Mg(II) hydroxide is one system which disproves the generally accepted views on dinitrogen as a very inert molecule (several other examples of such systems are presented later). N₂ can be very active in systems which are neither strong acids or bases nor too strong reductants. The important condition for dinitrogen to reveal high chemical reactivity in protic media with a comparatively weak reductant is the possibility to accept at least four electrons in an intermediate polynuclear complex including several electron donors.

4.2.2. Soluble complexes of vanadium(II)

The exact structure of the intermediate polynuclear V(II) complex in the mixed V(II)–Mg(II) hydroxide is of course difficult to determine, and it was important to find a homogeneous system reducing N₂ in protic media. This was realized in 1972 for complexes of V(II) with catechol and substituted aromatic diols which were able to effectively reduce dinitrogen in homogeneous water and alcohol solutions [71]. In the case of catecholate complexes in water, the reaction proceeds in the pH 8.5–13.5 range with maximum yields at approx. pH 10. For substituted catechols, the pH range corresponding to the most active complexes which react with N₂ may differ noticeably (Table 5). Later, the number of catecholate V(II) complexes active towards N₂ was greatly increased [73], but this family of V(II) complexes with aromatic

Table 5

Homogenous dinitrogen reduction by V(II) complexes with diols at room temperature, [V(II)] = 0.05 M; [diol] = 0.5 M

Diol	Solvent	$P(N_2)$ (atm)	Time (h)	NH ₃ yield (%)	pH
Catechol	CH ₃ OH	1	0.03	47	^a
Catechol	CH ₃ OH	15	0.17	75	^a
Catechol	H ₂ O	100	1.5	60	10.5
Gallic acid	H ₂ O	100	4.0	48	12.9
Pyrogallol	H ₂ O	100	4.0	60	13.5

^a Catechol:NaOH = 1:4.14.

diols and similar compounds remains unique: no other complexes have been found which would reduce dinitrogen in protic media homogeneously with reasonably high products yields. Hydrazine formation was also reported in homogeneous water solution (approx. pH 4.5) containing V(II) and α,ω -dicarboxylates, $^-OOC-(CH_2)_n-COO^-$, with the highest yields for $n=5$ or 6 [74]. The yields, though very small (approx. 0.01%), are reported to correspond to the equilibrium

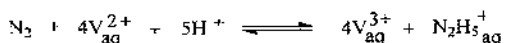

The authors [74] explain these results via a binuclear complex V–NN–V with carboxylate ligands coordinating two V ions in an appropriate way to form the cyclic complex with dinitrogen.

The reduction of dinitrogen by vanadium(II) catechol complexes in methanol occurs at room temperature and atmospheric N₂ pressure. The yield of NH₃ which is the only reaction product reaches 75% with respect to V(II) as a one-electron reductant. In aqueous solutions such yields are observed only at elevated N₂ pressures. In the absence of dinitrogen, a parallel reaction of V(II) oxidation by solvent protons proceeds with H₂ evolution. As the N₂ pressure increases, the yield of NH₃ increases and that of H₂ decreases due to the inhibition of the competing reaction of H₂ formation. However, at no pressure does the yield of NH₃ exceed 75%, 25% of electrons being used for H₂ formation. Thus, the stoichiometry of the reaction at saturating N₂ pressures corresponds to the following equation:

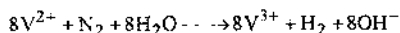

Acetylene is quantitatively reduced by vanadium(II) catecholate to ethylene with *cis*-dideuteroethylene formed selectively from C₂D₂, similar to the enzymatic reduction of acetylene by nitrogenase. The pH range for the reduction of acetylene is much broader than for dinitrogen (from approx. pH 5 to concentrated alkaline solution).

Carbon monoxide inhibits the formation of ammonia in a manner similar to that observed in the enzymatic reaction, but apparently, unlike the enzyme, V(II) catecholate reduces carbon monoxide mainly to methanol. Formaldehyde is also

produced in low yields, but using ^{14}CO it was found that more than 90% of carbon monoxide reduction to methanol proceeds without intermediate formation of formaldehyde [72].

Kinetic studies of the oxidation of the V(II) catechol complex in the presence of dinitrogen produced the following equation for the reaction:

$$-d[\text{V}^{\text{II}}]/dt = k_1[\text{V}^{\text{II}}]^2[\text{N}_2] + k_2[\text{V}^{\text{II}}]^{0,5}$$

The first term corresponds to the reduction of dinitrogen to ammonia, and the second to the parallel and independent reaction of H_2 evolution from the solvent protons.

Hydrazine, which could be the intermediate in the reduction is easily and quantitatively reduced to ammonia in the vanadium(II) catechol solutions. When the reaction of dinitrogen reduction is stopped, in its initial stages, by the addition of acid or oxidant (VOSO_4), a small quantity of hydrazine is found. However, a kinetic study of hydrazine reduction has revealed that its rate constant is at least two orders of magnitude smaller than necessary for free hydrazine to be the only intermediate producing ammonia. The results show that hydrazine is formed at the decomposition of an intermediate which contains a single N-N bond and appears to be a vanadium hydrazido derivative. Later, similar results indicating intermediate N_2^{2-} derivative formation were obtained in the enzymatic dinitrogen reduction by Mo-nitrogenase, and N_2H_4 itself was found for V-nitrogenase, indicating that such an intermediate is formed in the latter case too.

The second order of V concentration in the rate equation for N_2 reduction, and at the same time the one-half order for dihydrogen formation, are indicative of a complex of polynuclear structure. It is possible, for example, to assume that the active complex contains four V atoms and two complexes are needed to reduce N_2 to ammonia, whereas a binuclear complex produces dihydrogen and this binuclear complex is formed in equilibrium dissociation of the tetramer into two monomers. In this case, H_2 formation coupled with N_2 reduction could be explained by assuming that, after ammonia formation by the octamer, a dimer of V(II) is formed, readily producing H_2 .

Although the complexes present in solution have not been isolated and their exact structure is still unknown, important information about the state of the complexes was obtained from their EPR spectra [75]. Addition of lithium methylate or sodium methylate to the solution of V^{2+} and catechol in methanol results in loss of the spectrum of free V^{2+} and appearance of new signals which were attributed to three V(II) catechol complexes replacing each other at different methylate concentrations. At low methylate concentrations, a complex exists whose EPR signal has a g-factor 2.006 and consists of 22 components. Increase in the methylate concentration leads to a drop in the intensity of this signal and increase of the intensity of another signal with g-factor approx. 5.3 consisting of ten components. The intensity of the latter signal reaches a maximum at $[\text{LiOCH}_3] = 0.57\text{--}0.60$ M, and in the case of sodium methylate at $[\text{NaOCH}_3] = 0.7\text{--}0.8$ M. Further increase of methylate concentration completely removes the 22 component signal and leads to a decrease in the intensity of the ten component signal. Instead, a new signal appears and increases its intensity.

It consists of three lines with g-factors 4.50, 3.41 and 2.00 which change their intensities in the same way with increase of base concentration and evidently belongs to one complex.

The 22 component EPR spectrum of the first complex (designated **X**) was attributed to three equivalent V atoms with strong spin exchange between them [75]. The simplified structure of the complex may be presented as follows:

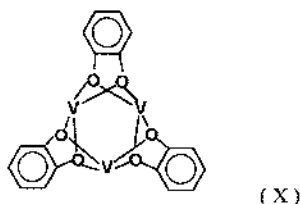

The spectrum of the second complex **Y** may be explained by assuming that it also contains three V atoms, but without noticeable spin exchange interaction. The observed ratio of intensities 1 : 1 : 3 : 3 : 3 : 3 : 3 : 2 : 2 corresponds to the superposition of eight lines corresponding to two equivalent V atoms and eight lines corresponding to one V different from the first two and therefore somewhat shifted in g-factor.

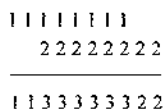

This trinuclear complex **Y** is apparently less rigid than the first, and they are in equilibrium:

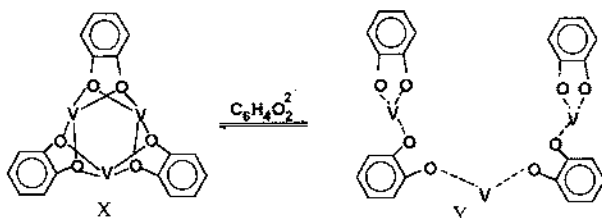

The third complex **Z** appears to be a mononuclear octahedral V(II)(catecholate)₃. The structure of the similar but more stable V(III)(catecholate)₃ was determined by X-ray analysis [76].

Thus, three complexes are in equilibrium with each other, and the equilibrium is shifted to the right with increase in base concentration



This is apparently due to increase in negative charge and, therefore, destabilization of the trinuclear complex. Initially, this leads to weakening of the bridges and the cleavage of one of the bridges to produce the complex **Y**, and at higher base concentration to decomposition of the trinuclear complex to the mononuclear species.

Considering the dependence of the reaction rate on base concentration, it is clear

that both the rigid trinuclear **X** and mononuclear **Z** complexes are not active towards dinitrogen since the system is inactive in the range of base concentration where these complexes are present as the main species. The concentration of the flexible trinuclear complex reaches a maximum just in the region of base concentration where the system is most active towards N_2 , therefore it could be the active species. The reaction rate was found to be proportional to h^2 (h is the intensity of the EPR signal of **Y**) confirming this assumption quantitatively. Thus, a trinuclear complex activates dinitrogen and another similar complex is needed to perform the reduction. This may be explained by the following equilibrium with dinitrogen forming a bridge between two V atoms in the flexible complex **Y**:

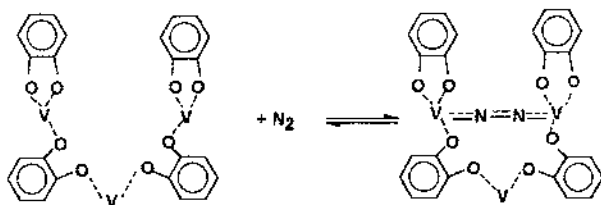

The rate determining step is the interaction of the intermediate complex with another **Y** particle to form a tetranuclear complex, V_4N_2 , and a dimer of $V(II)$ which reacts with solvent protons to form H_2 . The structure of the tetranuclear intermediate is unknown, but some hint may be derived from the structure of mixed-valence tetra-vanadium complex presented below. N_2 coordination in the complex may be tentatively suggested as $v \cdots N \equiv N \cdots v$ In the presence of an added acid the complex

produces hydrazine, presumably via a hydrazine derivative. The following general scheme can be suggested:

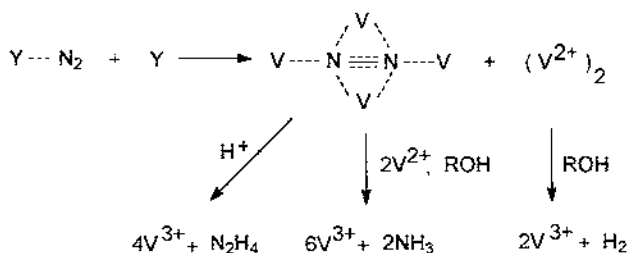

This scheme, which nicely explains all the facts concerning the dinitrogen reduction, fails to explain the one-half order for the parallel and independent dihydrogen evolution. There are some indications that unlike dinitrogen reduction, H_2 formation is sensitive to impurities present in the solution and, perhaps, is not so simple (presumably requiring some catalyst). The principal result of these studies on the vanadium(II) catecholate reduction of dinitrogen is the evidence for a polynuclear complex activating and reducing N_2 , and this invokes no doubts. Other aromatic diols may form somewhat different complexes with bivalent V, but all of them are polynuclear.

4.2.2.1. *The structure of the vanadium di-tert-butylcatecholate complex.* Other evidence for polynuclear vanadium catecholate complexes follow from the structure of a complex produced in alcoholic solutions of V(II) with di-*tert*-butylcatecholate [77]. The complex (Fig. 10) contains four V ions, two of them being bivalent and two others trivalent, but they are indistinguishable, thus their oxidation state is 2.5, and the complex may be considered an intermediate in V(II) oxidation to V(III). Each V atom exhibits distorted octahedral coordination involving oxygen atoms. Sodium atoms in the complex have a coordination of a distorted tetrahedron formed by oxygen atoms. Each of the sodium atoms is coordinated by two oxygen atoms of methanol molecules and two oxygen atoms of different catechol molecules. Owing to this coordination, oxygen atoms are μ_2 -bridging Na and V atoms. One of the three independent catechol molecules participates in the coordinating the V atoms by only one oxygen atom, while the second atom is protonated and does not participate in the metal coordination. Apparently, the bulky *tert*-butyl substituents prevent formation of a mononuclear complex of V(III) with three catecholate ligands, as occurs with nonsubstituted catechol and the V(III) formed remains bound to nonoxidized V(II). Accordingly, both dinitrogen reduction and dihydrogen evolution proceed with V(II) *tert*-butylcatecholate only to 50% of the full extent of V oxidation, and the subsequent process develops very slowly. The structure shows the catechol molecule as a bidentate ligand at a single V ion and a bridging ligand connecting two V ions. The structure may suggest to us a similar bonding in the active polynuclear complexes which reduce dinitrogen (e.g. μ_3 -oxygen bridge may be partially cleaved at V(III) reduction to open the sites for N₂ coordination).

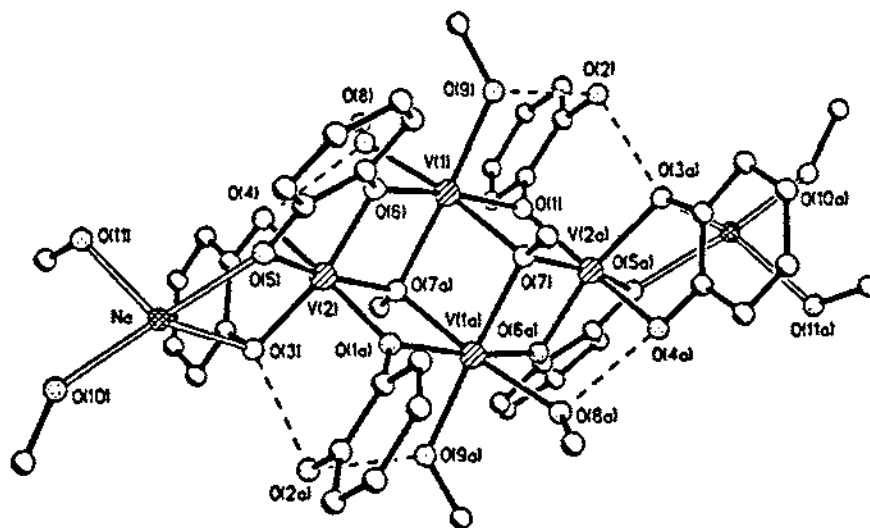

Fig. 10. Crystal structure of the V-di-*tert*-butylcatecholate complex (tert-butyl groups and H-atoms omitted).

4.2.3. Catalytic dinitrogen reduction

A catalytic system for dinitrogen reduction requires the presence of, besides a catalyst, a sufficiently strong reducing agent which would reduce dinitrogen coordinated on the catalyst. The catalyst (a polynuclear complex) may participate in the reduction, oxidizing itself, then the reductant should be able to restore the initial state of the catalyst. To perform successive catalytic cycles, the catalyst with coordinated N_2 should react with new molecules of the reducing agent (e.g. dihydrogen). Another possibility is to realize a system similar to nitrogenase with electron (and proton) flow to coordinated N_2 from the reductant via electron transfer agents. Thus, the system must possess electroconductivity to ensure the electron flow. Another obvious example would be a catalytic complex adsorbed at a cathode in an electrochemical reduction. The first candidate to be a catalyst from the data of Table 4 is Mo(III), which activates N_2 only in the presence of a stronger reducing agent such as $Ti(OH)_3$, $Cr(OH)_2$ or $Ta(OH)_3$. Presumably these strong reductants take part in a process which may be called reductive coaction. Mo(III) activates dinitrogen in a bi- or polynuclear complex, forming an intermediate, (e.g. of the type $Mo \equiv N \equiv N \equiv Mo$), which is unable to produce hydrazine or ammonia at the expense of Mo oxidation since no reduction takes place with Mo(III) complexes alone in protic media. The reaction may become thermodynamically favorable if a stronger reducing agent, situated nearby, will simultaneously reduce Mo to its initial trivalent state.

The first catalytic system for dinitrogen reduction in protic media was realized with Mo(III) as a catalyst and titanium(III) hydroxide as a reductant. With pure $Ti(OH)_3$, the yield of the products of N_2 reduction, in the presence of Mo(III) formed in the process of coprecipitation of both metal hydroxides by addition of alkali, only reaches, at best, equimolar amounts with respect to Mo, even at elevated temperatures and pressures of dinitrogen. In the presence of salts of some other metals in solution before the addition of alkali, e.g. Mg^{2+} , Ca^{2+} or Sr^{2+} , the yields increase and the system becomes catalytic. The effect of magnesium salts turned out to be particularly pronounced. The yields of hydrazine and ammonia greatly increase, and at high temperatures and pressures can reach several hundred turnovers per Mo present. The highest yields are obtained when the ratio of $Mg^{2+} : Ti^{3+}$ is 1:2. At this ratio, a compound of formula $MgTi_2O_2$ is produced that forms fine crystals, as revealed by X-ray analysis and electron microscopy. The catalytic effect of Mo(III) is observed when Mo(III) complex is adsorbed at the surface of $MgTi_2O_2$. Accordingly, whereas for mixed hydroxides it is essential to have both metals present in a homogeneous solution before the addition of alkali, for the catalytic N_2 reduction $MgTi_2O_2$ can be formed beforehand and the Mo catalyst can subsequently be added, demonstrating the catalytic activity.

Experimental results show that the mechanism of catalytic action involves reductive coaction of titanium ions surrounding the Mo catalyst, oxidation of these ions to titanium(IV), while coordinated dinitrogen is reduced to a hydrazine derivative, and subsequent electron transfer from the remote titanium ions to the catalytic center. The magnesium-titanium compound, $MgTi_2O_2$, possesses semiconducting properties, and evidently the Mo-dinitrogen complex on its surface forms an electron

trap. Dihydrogen is evolved in a fast reaction in the absence of dinitrogen, particularly at high temperatures. The introduction of the Mo catalyst, even in a very small amount compared with titanium, strongly inhibits H₂ evolution in the presence of dinitrogen, and the oxidation of titanium to the four-valent state proceeds for much longer. This may be explained by a mechanism in which the Mo complexes are adsorbed at the active sites of MgTi₂O₂; dinitrogen forms intermediate complexes with Mo(III), preventing the electron flow to the hydrogen evolution centers. Coordinated dinitrogen is then reduced to hydrazine or to ammonia with the participation of the solvent protons. The dependence of the reaction rate on dinitrogen pressure shows the Michaelis-type form which permits one to estimate an equilibrium constant for dinitrogen complex formation and the rate constant for the reduction of activated dinitrogen in the complex. Temperature dependencies of the constants give: $\Delta H = -7 \text{ kcal mol}^{-1}$ for the enthalpy and $\Delta S = 17 \text{ e.u.}$ for the entropy of the complex formation equilibrium, and $E = 19.8 \text{ kcal mol}^{-1}$ for the activation energy for N₂ reduction in the complex [78].

4.2.3.1. Catalytic dinitrogen reduction by sodium amalgam [66,67]. The mechanism proposed for the catalytic N₂ reduction by electroconductive reductant has prompted the use of amalgams, particularly sodium amalgam, as reducing agents. Sodium amalgam is a strong reductant (redox potential for $\text{Na/Hg} \rightleftharpoons \text{Na}^+/\text{Hg}^+ + e$ is -1.84 V); however, in contact with water or alcohol it is reasonably stable. Being a liquid it can easily be divided into small droplets, by shaking or agitating, to increase the surface to volume ratio and thereby make a more effective contact with the solution. Finally, the amalgam can be prepared electrochemically using a mercury cathode and passing electric current through a solution containing sodium ions; therefore, it can be used in the electrochemical reduction of dinitrogen.

Introduction of the sodium amalgam increased the yield of the reduction products, hydrazine and ammonia, in the catalytic system based on Mo(III) and MgTi₂O₂ described above. Apparently, amalgam transfers its electrons through the magnesium–titanium mixed oxide to the Mo catalytic center. Obviously the electron-transferring material is unnecessary, and the amalgam can serve, in principle, as the only reducing agent. Accordingly, if one shakes the Mo(V) compound formed by dissolving MoCl₅ in methanol (without titanium–magnesium reductant), under 100 atm N₂ with sodium amalgam, hydrazine can be detected in the solution. However, the yields are extremely small and irreproducible. Nevertheless, the system was subsequently developed and transformed into the most active among known non-biological catalytic systems for the reduction of dinitrogen at ambient temperature and pressure.

The first improvement of the system was achieved when the magnesium salt was added to the solution of MoCl₅ in methanol before reducing the latter by sodium amalgam. The yields, albeit still low, became reproducible and the reaction kinetics could be measured to draw conclusions about the nature of the reaction rate controlling step. Apparently, magnesium ions which are involved in the complexes polynuclear structures (vide infra) stabilize the complexes and may make them more suitable for the activation of dinitrogen. The system's low activity was most probably

due to insufficient contact of the complexes with the surface of the amalgam. Therefore, it was necessary to find a means to bind the complex to the amalgam to improve the electron transfer from the reductant to the catalytic complex. After a long search, following the example of living nature, a phospholipid (phosphatidylcholine) was tried which strongly increased the reaction rate and the product yield [79] (Table 6). It became possible to study the reaction at atmospheric pressure and room temperature. This further facilitated the search for system improvement. Finally, phosphines were found to increase the yield of the dinitrogen reduction products, hydrazine and ammonia [80].

Hydrazine and ammonia are produced in parallel reactions, their ratio depending mainly on the nature of the catalytic complex and also on the length of phosphatidylcholine aliphatic chains. In the case of a specially prepared polynuclear Mo complex (vide infra), hydrazine is the main product and the yield of ammonia amounts to only approx. 10% of total dinitrogen reduction.

After all the improvements, the specific activity of the catalytic system in dinitrogen reduction (per catalytic complex) reached or exceeded that of nitrogenase. Up to 1000 turnovers can be observed with respect to Mo catalytic complex at atmospheric pressure, and more than 10^4 000 turnovers at elevated pressure (Table 6).

The increase in the catalyst activity is also reflected in the activation energy E_{act} of the reaction (although empirical values of E_{act} do not necessarily correspond to the step of dinitrogen reduction). The effective activation energy drops from 18 kcal mol⁻¹ without the phospholipid (but in the presence of Mg²⁺) to 8.7 kcal mol⁻¹ with the phospholipid, and further to virtually zero in a full system with improved catalyst [81].

The role of the phospholipid is to form a thin film on the surface of the amalgam with the catalyst incorporated and thus bound to the electron donor (Fig. 11). The film is kept at the surface, presumably because of the attachment of the phosphatidylcholine positive heads to the negatively charged surface. Electrons move from the amalgam to the catalytic complex to perform the catalytic reduction. Proton-containing molecules (water and alcohol) diffuse through the hydrophobic part of the film to protonate the activated dinitrogen and to form the final products. The

Table 6
Development of the catalytic systems on Na(Hg) and Mo(III) (methanol, 20°C)

System	$P(N_2)$ (atm)	Specific rate [N ₂] _{red} /[Mo] (s ⁻¹)	Yield (N ₂ H ₄ + 1/2NH ₃)	
			per Mo (cycles)	per Red (%)
Mo ^{III} + Na(Hg)	70	<0.0001	0.5	0.004
+ Mg ²⁺	70	0.003	2.5	0.02
+ PL	70		2.5	0.25
+ PL	1	0.05	3.5	0.03
cat. improved				
+ R ₃ P	1	0.4	200–1000	5
+ R ₃ P	70		≈ 10 000	≈ 30

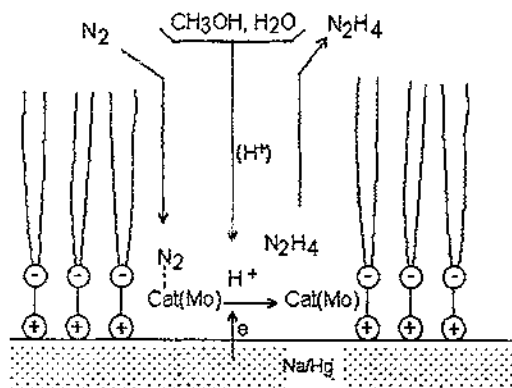

Fig. 11. The film of phospholipid on the surface of amalgam with the catalyst incorporated.

hydrophobic film helps to keep the amalgam droplets separated and prevents their fast agglutination. This leads to an increase in the surface to volume ratio, and thus to an increase in catalytic activity. Presumably, the hydrophobic film also helps to control the proton flow to the catalyst from the solution. Indeed, the dihydrogen evolution is also catalyzed by the Mo complexes and facilitated by the presence of the phospholipid, but its rate increase is much less pronounced than that of dinitrogen reduction.

Apparently, the chemical nature of the polar heads of the phospholipid is important for the incorporation of the catalyst, since many other surface-active materials, including phospholipids, proved to be inactive; e.g. tetraalkylammonium salts with long aliphatic chains, although they form a film on the surface of the amalgam, failed to make a catalytic system with the Mo complexes. Nevertheless, polyvinyl alcohol turned out to be another substance of quite different nature to act as a cocatalyst in dinitrogen reduction by sodium amalgam, albeit somewhat less effectively than the phospholipid, indicating that both the phospholipid and polyvinyl alcohol films do not drastically change the nature of the catalytic complex [82].

The role of phosphines in increasing the reaction product yields is more difficult to elucidate. The effect of the phosphines depends on their basic strength and size, increasing for stronger bases and smaller molecules. An evident suggestion should involve the formation of PR_3 complexes with Mo compounds. However, even the ratio of hydrazine and ammonia is not changed in the presence of phosphines, therefore it is unlikely that the nature of the catalyst is changed at all. Moreover, the initial rate of reduction remained virtually unaffected in the presence of phosphines [82]. Therefore, their most probable role is to increase the catalytic chain without affecting the catalyst itself. Perhaps, one possible way for catalyst destruction is the reduction of Mo by the amalgam to a low oxidation state, perhaps Mo(0). This reduced Mo may react with other species of the catalytic complex reducing Mo(III) and deactivating the complex. The formation of the phosphine complex may stabilize the low-valent Mo complex and prevent or slow down the reaction with Mo(III) in the catalyst, thus increasing the catalytic chain and the yield.

This catalytic system provides an example of the development of a catalyst along the lines of biological catalysis, to construct an organized molecular assembly, approaching in some aspects the enzymes and drastically improving its catalytic performance.

4.2.3.2. *The structure of polynuclear molybdenum complexes [83].* Two bi- and one polymolybdenum(V–VI) complexes containing $-\text{O}-\text{Mg}-\text{O}-$ and $\mu\text{-O}$ bridges have been isolated from the catalytic systems and their structure investigated by X-ray diffraction. Crystals of all three Mo complexes isolated from the solution and suitable for X-ray analysis were extremely unstable out of contact with the solution, easily collapsing to a powder. The single crystals were studied using a special low temperature technique for data collection.

The structures of the complexes **1** and **2** (Figs. 12 and 13) are similar, differing only by the number of terminal methoxy (OMe) and oxide (O^{2-}) groups at the Mo atoms. The central frame of **1** and **2** contains two Mo and two magnesium atoms (Mo(V) and Mo(VI) in the cases of **1** and **2** respectively). They are linked by two $\mu_3\text{-OMe}$ ligands and four $\mu_2\text{-OMe}$ ligands. Each magnesium atom is also coordinated

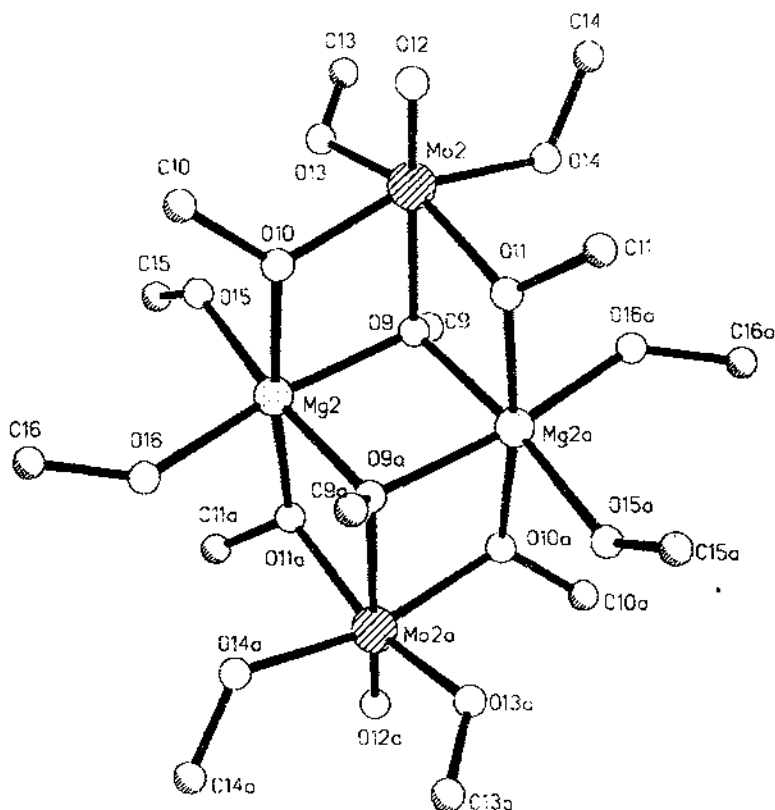

Fig. 12. View of the complex **1**: $[\text{Mo}(\text{V})\text{OMg}(\text{MeOH})_2(\text{OMe})_5]_2$.

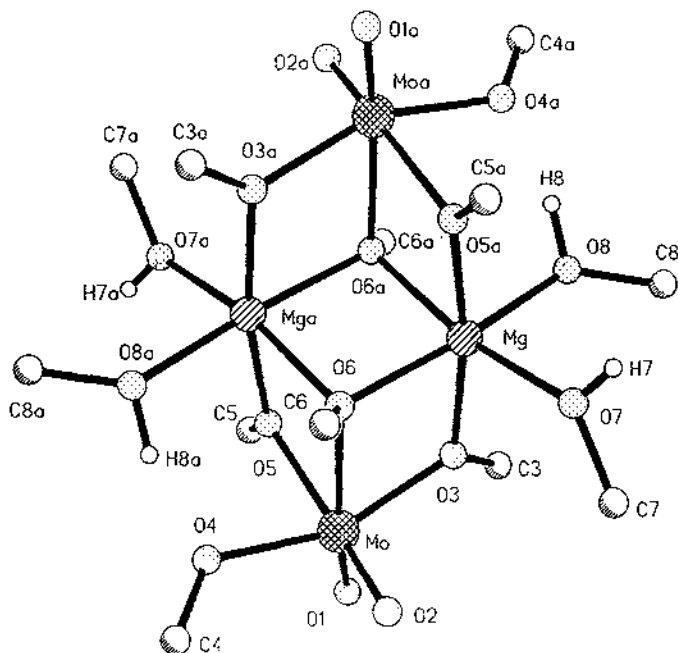

Fig. 13. View of the complex 2: $[\text{Mo(VI)O}_2\text{Mg}(\text{MeOH})_2(\text{OMe})_4]_2$.

by two methanol molecules and as a result the total Mg coordination is a distorted octahedron.

The mixed valence Mo(V)–Mo(VI) complex 3 includes a number of weakly bonded methanol molecules, and this probably explains its particular instability outside the solution. The structure of the centrosymmetric dianion of 3 is shown in Fig. 14. The architecture of this complex is more complicated than that of 1 and 2. Metal atoms of the cluster are linked by bridging oxygens of the μ_2 -, μ_3 - and μ_4 -types, bridging μ_2 -OMe groups and also Mo(1)–Mo(2a) and Mo(1a)–Mo(2) bonds between the Mo(V) atoms with bond length 2.588(1) Å. The atoms Mo(3) and Mo(4) are formally six-valent. Each Mo atom has one terminal oxide (O^{2-}) ligand.

Mo in all these complexes can be reduced to the Mo(III) state when placed in contact with sodium amalgam in methanol.

The complexes of Mo(III) formed can be isolated from the solution by additions of ether. Dark powders precipitated from the solutions were filtered and washed with a mixture of ether and methanol. Analysis for Mo and magnesium has shown that the ratio $[\text{Mg}]:[\text{Mo}]$ did not change during reduction. All the complexes are diamagnetic as well as their precursors. The results obtained upon Sephadex gel filtration of the complexes 1 and 3 are shown in Fig. 15, together with those obtained for the complexes produced by their reduction. The lag time of the complexes remains virtually the same after reduction, thus their molecular volumes, and probably their nuclearity, remain essentially unchanged during the reduction, although Mo(III) complexes are probably slightly more voluminous than their precursors.

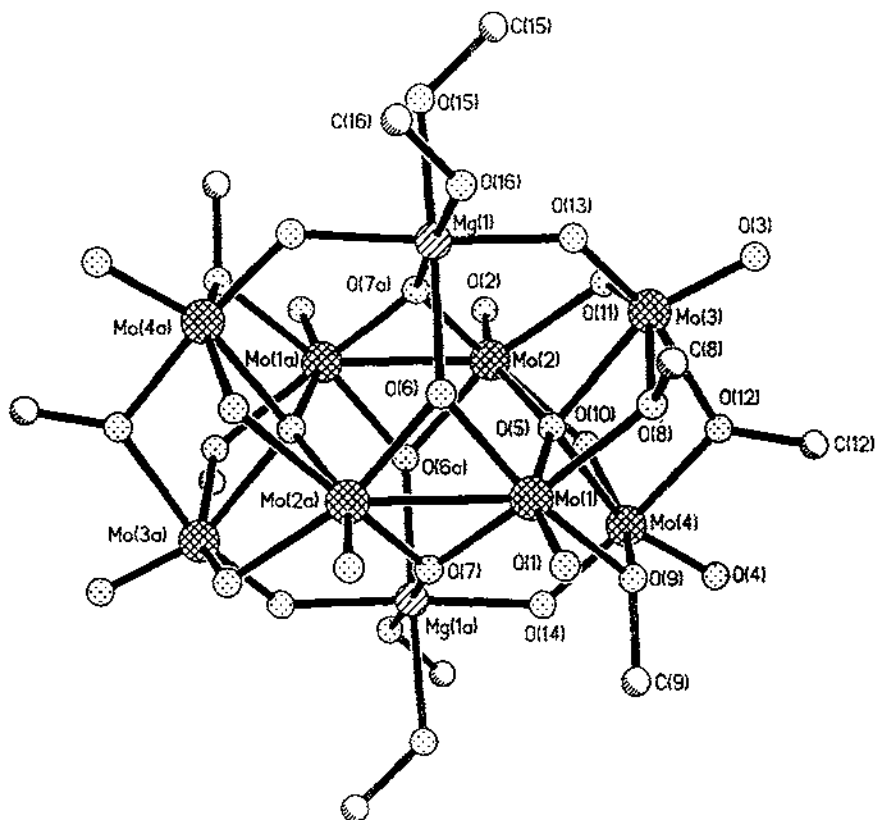

Fig. 14. General view of the centrosymmetric dianion of complex 3: $\{[Mg_2Mo_8O_{22}(OMe)_6(MeOH)_4]^{2-}[Mg(MeOH)_6]^{2+}\} \cdot 6MeOH$.

The eight-nuclear complex III, when reduced to the Mo(III) state, then kept in acidic methanol solution (1×10^{-2} M HCl) for several hours and subsequently made alkaline by sodium methylate, increases its molecular volume and presumably the number of Mo atoms as may be inferred from the gel chromatogram shown in Fig. 15.

Fig. 16 shows the kinetic curves for hydrazine formation following dinitrogen reduction by sodium amalgam in the presence of three complexes: Ia, formed at the reduction of I; IIIa, formed at the reduction of III; and IVa formed after polymerization of the complex IIIa in acid solution. In all cases, the Mo concentrations were the same. It can be seen that, under identical conditions, the reaction rate and the yield of hydrazine are increased with increasing number of Mo atoms in the complexes. Complex IIa, produced in the reduction of II, demonstrated the same activity as Ia. Taking into account that a linear dependence of the reaction rate on complex concentration was observed in the range of Mo concentrations chosen for the comparison, it may be concluded that the catalytic rate constants are even more strongly dependent on the number of Mo atoms in the complexes than they may

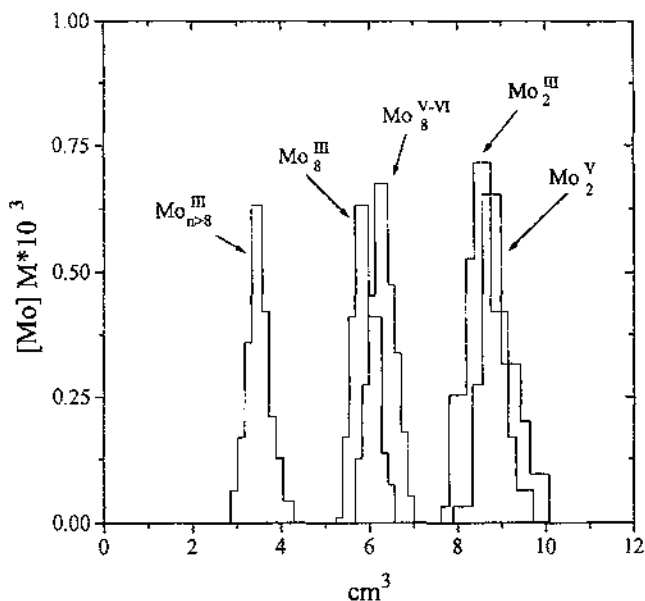

Fig. 15. Gel chromatogram of the Mo complexes. The x-axis is the volume of the solvent (methanol) used to wash the column. The larger the size of the complex the earlier it comes from the column (because large complexes cannot use small cavities in the gel for adsorption).

seem in Fig. 16, since at equal concentrations of Mo the number of complexes will be correspondingly larger in the case of lower molecular weight complexes.

Although the structures of the Mo(III) complexes, which are catalysts for dinitrogen reduction, remain undetermined due to the difficulties in preparation of single crystals for X-ray study, some conclusions concerning their composition and structure may be drawn on the basis of the structures of their precursors. Conservation of complex volumes and magnesium atoms during the reduction permits the suggestion that the structures do not change too much during the reduction. All the evidence shows that O^{2-} ligands disappear from Mo atoms at the reduction and are probably replaced by MeO^- ligands or coordinated methanol molecules. Other details of the structure may remain unchanged, though all the ligands, including bridging OMe groups, are probably more loosely bound to low-valent Mo(III) than to Mo(V) or to Mo(VI). The catalytic activity of the complexes seems to increase with increasing number of Mo atoms in the complexes. This finding supports the conclusion that dinitrogen becomes more activated in complexes with an increase of their electron capacity, since this helps to decrease the NN bond order in the intermediate complex and to increase the negative charge on N atoms of coordinated dinitrogen.

As to the exact path for dinitrogen activation in the catalytic complexes, the structures available do not yet provide a final answer to this problem. Apparently, dinitrogen can replace two ligands on Mo to form an intermediate capable to produce hydrazine upon protonation. A binuclear complex with bridging dinitrogen might be suggested:

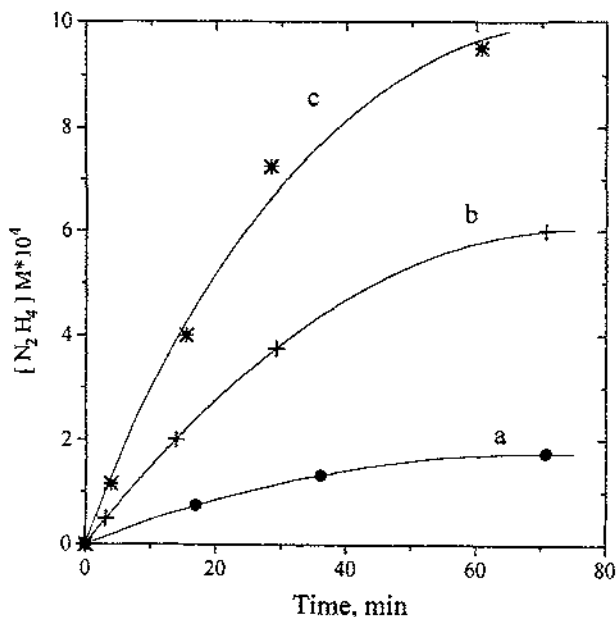
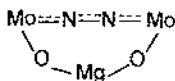
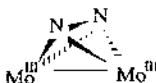

Fig. 16. Kinetics of hydrazine formation in dinitrogen reduction in the presence of three Mo complexes: (a), formed by reduction of complex $[\text{Mo}(\text{V})\text{OMg}(\text{MeOH})_2(\text{OMe})_5]_2$ (Fig. 12); (b), formed by reduction of complex $\{[\text{Mg}_2\text{Mo}_8\text{O}_{22}(\text{OMe})_6(\text{MeOH})_4]^{2-}[\text{Mg}(\text{MeOH})_6]^{2+}\} \cdot 6\text{MeOH}$ (Fig. 14); (c), acid treatment of complex 3 (Fig. 14).



32 with a structure similar to that in systems based on V(II) and discussed above. The essential role of magnesium ions which strongly increase the rate of N_2 reduction supports this mechanism. Forming a bridge between two Mo atoms, the magnesium atoms shift two Mo atoms from each other to a distance suitable to form a cyclic dinitrogen complex (shown above) and perhaps take part in coordination of N_2 . Another possibility is the formation of a bridging N_2 complex coordinated to Mo atoms by its π -bonds, i.e. of η_2 -type:



4.2.3.3. Dinitrogen reduction in the presence of iron complexes [85].

In view of the observation of an alternative nitrogenase based entirely on Fe, and of the structure of an FeMo-cofactor which suggests Fe as the likely core for dinitrogen activation, it is natural to expect the existence of Fe systems reducing dinitrogen in protic media. Apparently, iron(II) hydroxide is too weak a reducing agent to reduce dinitrogen, even in the presence of a stronger reductant, therefore $\text{Fe}(\text{OH})_2$ does not reduce N_2 either alone or when formed together with $\text{Ti}(\text{OH})_3$.

In the enzymatic system, sulfide ligands, being stronger one-electron donors than hydroxo- or oxo-ligands, apparently help to activate and reduce dinitrogen, hence suitable polyiron sulfide complexes are obviously likely candidates to be the catalysts in dinitrogen reduction. There are two reports [85] indicating the possibility to reduce N_2 to ammonia in methanol in the presence of Fe salts by lithium *p*-polyphenylene, a very powerful reducing agent. The activity of the system was found to increase in the presence of some organic and inorganic sulfides. The same reducing agent was reported to reduce dinitrogen catalytically in the presence of the polyFe–Mo carbonyl complex $Mo_2Fe_7S_8(CO)_{22}$ [84]. The yields, however, are low and the reductant is too strong to consider these systems as close models of nitrogenase, but the studies for systems similar to the nitrogenase cofactors are definitely very promising.

4.2.4. Electrochemical reduction

It is natural to expect that, at sufficiently negative potentials, the electrochemical reduction of dinitrogen could take place, providing a catalyst is present that is able to activate dinitrogen and be adsorbed at the cathode surface. To prevent hydrogen evolution at negative cathode potentials, it is necessary to use materials for the cathode that have a considerable overvoltage, such as mercury and lead. At a negative potential using a mercury cathode, ions of alkali metals can be discharged to produce an amalgam, which will serve as a reducing agent for N_2 reduction in the presence of the catalyst.

Dinitrogen reduction was detected under the conditions of electrolysis for the heterogeneous system containing a mercury cathode plus the $Ti(OH)_3$ –Mo(III) system [85]. The system showed a very pronounced dependence of the product (hydrazine and ammonia) yield on current density. The maximum for ammonia yield is observed at a current density of 0.5 A cm^{-2} ; the authors explain this by the change of the mercury electrode interface charge. At a current density of 0.5 A cm^{-2} there are optimum conditions for adsorption of the negatively charged hydroxide on the surface, and the potential is sufficiently negative to reduce dinitrogen. At lesser current densities, the potential appears to be insufficient, at larger ones the negative charge increases, impeding hydroxide adsorption on the electrode. Under optimum conditions, the current yield reaches 43% with respect to ammonia and 4% with respect to hydrazine.

In the seemingly homogeneous $Ti(OH)_3$ –Mo(III) system with additions of guanidine, the rate of hydrazine formation passes a maximum at a potential of -1.9 V . In the range of -1.6 to -1.9 V , a linear dependence of $\log V_{N_2H_4}$ on the potential is reported. The rate determining stage of the electrode process is thought to be electron transfer from the cathode to the catalyst active center containing the coordinated dinitrogen. The reaction was found to be sensitive to the concentrations of the base ($LiOCH_3$) and water. The latter serves as the main donor of protons, and additions of water are essential to keep the process going with constant rate for many hours, particularly at high base concentrations [86].

In the Na/Hg –Mo(III) complex system with the phospholipid coaction described above, the hydrazine formation rate was measured as a function of the sodium

amalgam potential [80]. The formation of hydrazine was found to start at the mercury cathode at potentials $E < -1.75$ V. At these potentials, the generation of sodium amalgam begins to take place. In the range of potential from -1.75 to -2.0 V the reduction rate is fully determined by the concentration of sodium in the amalgam, and does not depend on the polarization potential of the amalgam electrode. The dinitrogen reduction rate only increases with the shift to more negative potentials up to $E = -2.15$ V. This is explained by the presence of a purely electrochemical mechanism of N_2 reduction together with amalgam reduction in the range $-2.15 < E < -2.05$ V when the reaction rate is determined by the electron transfer to the reaction center. At $E < -2.15$ V all the reaction centers activating dinitrogen are reduced and a further shift of potential to more negative values does not influence the rate.

5. Dinitrogen complexes with transition metal compounds and the mechanism of N_2 reduction in the coordination sphere

The reactions of dinitrogen described in the previous section clearly involve intermediate dinitrogen complexes: this follows from all the experience of coordination catalysis where such complexes have been detected in reactions of olefins, acetylenes, carbon monoxide, dioxygen, etc. The search for intermediate complexes in catalytic reactions and their isolation is not an easy task, and investigation of similar but more stable model complexes contributed much to the understanding of the catalytic mechanisms.

Until the 1960s, dinitrogen complexes remained unknown. This could be attributed to their instability, and the results presented in the previous section seem to support this conclusion: all the indications are that the intermediate complexes are indeed very unstable.

The first dinitrogen complex isolated from solution was reported by Allen and Senoff in 1965 [87] as a product of the reaction of $RuCl_3$ with hydrazine. The complex was found to be $[Ru(N_2)(NH_3)_5]I_2$ and turned out to be remarkably stable. It was isolated in crystalline form and might be considered an inorganic diazo compound, rather than a real N_2 complex, the more so since it was obtained indirectly from N_2H_4 rather than from N_2 . However, a few months after the Allen and Senoff publication it was found [88] that similar complexes could be obtained directly from N_2 in a reaction:

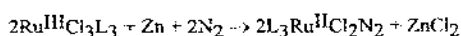

where $L \equiv H_2O$ or THF. Dinitrogen was found to react easily with coordinately unsaturated $L_5Ru(II)$ formed intermediately.

Another important development was the preparation by Taube et al. [89] of the first binuclear dinitrogen complex with $Ru(II)$

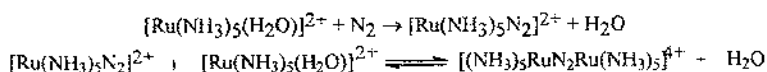

Thus dinitrogen was not only found to be able to add to coordinately unsaturated species, but also to replace ligands in coordinatively saturated ones (probably by a dissociative mechanism, again via a coordinatively unsaturated complex). Later, using these and other reactions, various dinitrogen complexes were prepared, initiating a new branch of coordination chemistry [90,91]. The structure of the complexes revealed a mostly linear structure of the fragments $M-N\equiv N$ and $M-N\equiv N-M$, and the NN bond was only slightly elongated compared with the NN bond in a dinitrogen molecule. Moreover, to the great disappointment of the chemists, dinitrogen in the coordination sphere of the complexes turned out to be as inert as free dinitrogen and did not enter any reaction besides replacement by other ligands to form free N_2 .

Now it is not difficult to provide an explanation for this inertness. The reactions in the coordination sphere are mainly two-electron processes, e.g. well-known insertion into $M-H$ or $M-C$ bond:

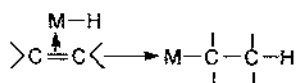

As we have seen in Section 1.1, two-electron reactions of this kind for dinitrogen are, as a rule, thermodynamically unfavorable. The thermodynamic stability of the N_2 complexes naturally only increases their chemical inertness. The four-electron reduction and protonation of the ruthenium(II)-dinitrogen complex:

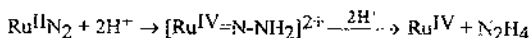

is thermodynamically forbidden and strongly shifted to the left.

The first intermediate complex of dinitrogen with a transition metal compound was detected in 1969 in one of the Vol'pin-Shur systems: $Cp_2TiCl_2 + i-PrMgCl + N_2$ in ether solution [61,62]. At low temperatures (less than $-60^\circ C$) an intensely blue colored complex (already mentioned above) was observed in solution under dinitrogen; later the equilibrium was established:

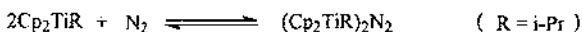

At $-60^\circ C$ in the presence of excess reducing agent, the complex undergoes a slow transformation to another complex $Cp_2Ti(MgCl)NNTiCp_2$, which produces hydrazine when decomposed by acid. Compared with the other complexes known at that time, the complexes looked very unusual. However, later they were found to be the first representatives of an important class of dinitrogen complexes (vide infra).

Meanwhile, new mononuclear dinitrogen complexes were synthesized, in particular, in 1969, complexes of $Mo(0)$, which played an important role in future development [92]. Within a few years, Chatt and his colleagues in Brighton found that mononuclear W and Mo dinitrogen complexes could be reduced upon protonation to produce ammonia and hydrazine. Interesting new reactions of dinitrogen were observed in coordination sphere. These discoveries were characterized by Chatt as the beginning of the new era in the chemistry of dinitrogen under ambient conditions [93].

5.1. Protonation of dinitrogen in mononuclear end-on complexes [93–97]

Table 7 presents typical examples of mononuclear complexes which can be protonated with subsequent dinitrogen reduction as well as those with inert dinitrogen. All the structural studies indicate that the N–N bond lengths in both classes of the complexes are only slightly increased when compared with free dinitrogen (approx. 1.12 Å in complexes vs. 1.0968 Å in free N₂) and are not informative with respect to dinitrogen chemical activity. The stretching frequency of the NN bond in the complexes, $\nu(\text{NN})$, which presumably reflects that the metal $d\pi$ donation into the N–N antibonding system is much more indicative, with low $\nu(\text{NN})$ corresponding to more basic ligating dinitrogen. The data are in general qualitative agreement with the theoretical expectations (see Section 1.1). The complexes are formed generally with electron-rich metal compounds. The reduction of dinitrogen in complexes through protonation proceeds only in those complexes which have strong basic properties. Complexes of different metals of the d^6 electron configuration behave differently, depending on the metal donor properties. Dinitrogen in complexes of V(–1), Mo(0) and W(0) can be reduced when protonated, while in complexes of Re(I) dinitrogen apparently cannot be reduced but can coordinate Lewis acids and dinitrogen complexes of Fe(II); Ru(II) or Os(II) neither coordinate acid nor reduce N₂ upon addition of acid. With platinum and palladium, complexes of dinitrogen are unknown, either for the M(IV) state (d^6) or the M(II) state (d^8). Complexes are formed mainly with electron donors since dinitrogen behaves in the complexes as a moderate acceptor and very weak donor. For the same metal, the ability to reduce coordinated dinitrogen increases with decrease of the metal valence. For example, there is almost no reduction in the case of $[\text{Fe}^{\text{II}}\text{H}(\text{N}_2)(\text{dmpe})_2]^-$ ($\text{dmpe} \equiv \text{MePCH}_2\text{CH}_2\text{PMe}_2$) but dinitrogen can at least be partly reduced to ammonia under the action of HCl in the complex $[\text{Fe}^0(\text{N}_2)(\text{dmpe})]$ [102].

It is also easy to see that the ability for the coordinated dinitrogen to be reduced

Table 7
X-ray and IR data on some mononuclear dinitrogen complexes [91,91,97,100,101]

Complex	$r(\text{M}-\text{N})$ (Å)	$r(\text{N}-\text{N})$ (Å)	$\angle \text{M}-\text{N}-\text{N}$	$\nu(\text{NN})$ (cm^{-1})
<i>trans</i> - $[\text{V}(\text{N}_2)_2(\text{dmpe})_2]^-^*$	1.915	1.130	180.0	1793
<i>trans</i> - $[\text{Mo}(\text{N}_2)_2(\text{dppe})_2]^*$	2.014	1.118	1.776	2020w 1970s
$(\text{Fe}(\text{N}_2)(\text{dmpe})_2)^*$				1975
$\text{FeH}(\text{N}_2)(\text{dmpe})_2$				2094
<i>trans</i> - $[\text{Re}(\text{N}_2)\text{Cl}(\text{PMe}_2\text{Ph})_4]$	1.97	1.06(3)	177	1920
$[\text{Ru}(\text{N}_2)(\text{NH}_3)_5]\text{Cl}_2$	2.10	1.12	180	2105
$[\text{Os}(\text{N}_2)(\text{NH}_3)_5]\text{Cl}_2$	1.84	1.16	175	2088
$\text{K}[\text{Co}(\text{N}_2)(\text{PMe}_3)_3]$	1.70–1.71	1.16–1.18	180	1795 1758

* Dinitrogen in the complexes are able to be protonated and reduced.

does not necessarily increase with complex stability. Often it is the other way round. Let us consider, for example, two complexes already mentioned $[\text{Fe}^{\text{II}}\text{H}(\text{N}_2)(\text{dmpe})_2]^+$ and *trans*- $[\text{V}(\text{N}_2)(\text{dmpe})_2]^-$. The stretching frequencies $\nu(\text{NN})$ in the IR spectra, which presumably reflect the metal donation into N–N antibonding system are equal to 2094 cm^{-1} for the first complex and 1763 cm^{-1} for the latter. Accordingly, only in the second complex is dinitrogen sufficiently activated to be effectively reduced upon protonation. At the same time, the Fe complex is relatively stable while the V complex easily loses dinitrogen; N_2 can be pumped away at room temperature.

The metal–dinitrogen bond in a complex is formed at the expense of the weakening of the N–N bond in dinitrogen. We may consider the M– N_2 bond dissociation energy, $D(\text{M}-\text{N}_2)$, (M is metal with co-ligands) as the difference: $D(\text{M}-\text{N}_2) = E(\text{M}-\text{N}) - \Delta(\text{N}\equiv\text{N})$, where $E(\text{M}-\text{N})$ is the M–N bond energy and $\Delta(\text{N}\equiv\text{N})$ is the decrease in the NN bond energy in the complex compared with triple NN bond energy in free dinitrogen. It is clear that $D(\text{M}-\text{N}_2)$ is small (the complex unstable) when both $E(\text{M}-\text{N})$ and $\Delta(\text{N}\equiv\text{N})$ are small (dinitrogen nonactivated), or when both $E(\text{M}-\text{N})$ and $\Delta(\text{N}\equiv\text{N})$ are large and, therefore, dinitrogen is strongly activated. For a given $E(\text{M}-\text{N})$, the increase in $\Delta(\text{N}\equiv\text{N})$ will lead to the activation of dinitrogen and, at the same time, to a decrease of complex stability.

Mononuclear end-on dinitrogen complexes (e.g. with Fe(0) or Mo(0)) are extremely unlikely candidates for the intermediates in biological dinitrogen reduction. They are clearly not the intermediates in chemical reduction of dinitrogen in protic media described in the previous section, since higher oxidation states of the metal compounds are functioning in both biological and model systems. Nevertheless, the results obtained from investigations of dinitrogen reduction in the coordination sphere of mononuclear complexes, and the comparison with other low temperature dinitrogen reactions, are very instructive for creation of a general picture of dinitrogen reactivity. Let us consider these reactions in more detail for especially well investigated complexes of Mo(0) and W(0).

5.1.1. Protonation and reduction of coordinated dinitrogen

The first reaction of a coordinated dinitrogen in an end-on mononuclear complex was that observed with $\text{W}(\text{N}_2)(\text{dppe})_2$ interacting with CH_3COCl :

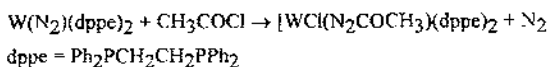

This was interpreted as being essentially an oxidative addition to a W– $\text{N}\equiv\text{N}$ fragment with nucleophilic attack of the coordinated dinitrogen on the carbon of the acetyl group [98]. Subsequently, this work was extended to protonation reactions in the same complex of the N_2 ligand and to alkylation by alkyl halides (RX) which generally proceed via attack of an alkyl radical, generated by homolysis of RX, upon coordinated dinitrogen.

When treated with an excess of halogen acid at 20°C the complexes *trans*- $[\text{M}(\text{N}_2)_2(\text{dppe})_2]$ (M \equiv Mo or W) undergo the reactions:

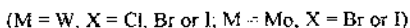
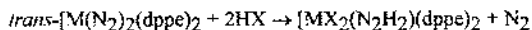

The N_2H_2 group has the hydrazido(2-) form in which it acts as 4-electron donor, so that the metal retains an 18e configuration. The structure of $\text{trans-}[WCl(NNH_2)_2(\text{dppe})_2]BPh_4$ (Fig. 17) shows that the $M=N-N$ unit is essentially linear and the N–N bond distance indicates a bond order greater than unity, the short M–N distance confirming the bond order close to three of this bond. All the evidence indicates that it is not a simple derivative of hydrazine, but rather a complex similar to binuclear complexes $MNNM$ (vide infra) with d^2-d^4 electronic configuration of each M. Thus 2H atoms are isolobal with a metal, having both σ - and π -bonds with coordinated dinitrogen. Although there is no further reduction of the coordinated dinitrogen, the N–N bond is strongly activated when compared with the initial dinitrogen complex.

The hydrazido(2-) complex can be dehydrohalogenated with a weak base to give a diazenido complex:



Treatment of the latter complex with acids regenerates the hydrazido(2-) complex; therefore, the diazenido complex may be regarded as a precursor to the NNH_2 complex, in a stepwise protonation of ligating dinitrogen.

Attempts to reduce the NNH_2 ligand in the above complexes with different reducing agents failed, but moderate yields of ammonia (0.24 mol per atom) were obtained when $[MoBr_2(NNH_2)(\text{dppe})_2]$, together with $\text{trans-}[Mo(N_2)_2(\text{dppe})_2]$, was treated with aqueous HBr in *N*-methylpyrrolidone or propylene carbonate followed by removal of solvent and Kjeldahl distillation. Protonation and further reduction of NNH_2 ligand is probably the result of phosphine displacement; therefore, monodentate phosphines were used and high yields of ammonia (with a little hydrazine in some cases) were observed on treatment of the complexes $\text{cis-}[M(N_2)_2(PMe_2Ph)_4]$ or $\text{trans-}[M(N_2)_2(PPh_2Me)_4]$ ($M \equiv Mo$ or W) with sulfuric acid in methanol at 20°C [99]. For the W complex the reaction proceeds according to the equation:

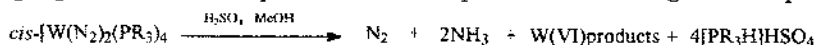

For the Mo complex the yield of ammonia only reaches approx. 0.7 mol per metal atom, the remainder evolving as free dinitrogen, with Mo being oxidized to $Mo(III)$.

The clear stoichiometry of the protonation reaction was well defined [103] in the

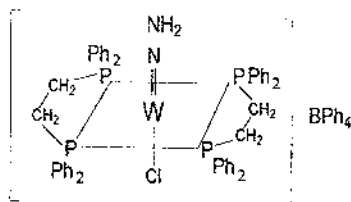
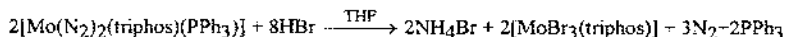

Fig. 17. The structure of $\text{trans-}[WCl(NNH_2)_2(\text{dppe})_2]BPh_4$.

case of the molybdenum triphosphine complex $[\text{Mo}(\text{N}_2)_2(\text{triphos})(\text{PPh}_3)]$ (triphos $\equiv \text{PhP}(\text{CH}_2\text{CH}_2\text{PPh}_2)_2$):



On treatment with HBr in THF the complex gives 0.7 mol of ammonia per mole of complex, together with the formation of 1.3–1.5 mol of dinitrogen per Mo atom [100].

Some indications of probable intermediates in these reactions were obtained when halogen acids HX (X \equiv Cl, Br or I) were used instead of sulfuric acid in methanol. Dihalo-hydrazido(2–) complexes were isolated in these cases:

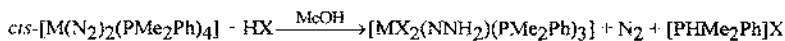

Substitution reactions carried out on the hydrazido(2–) complexes produce several complexes with the NNH_2 ligand, with N–N bond distances only varying a little with the nature of co-ligands. However, the further protonation reactions of these hydrazido(2–) compounds are strongly dependent on the ligand environment. Thus on treatment with $\text{H}_2\text{SO}_4/\text{MeOH}$ followed by base distillation, the compounds $[\text{MX}_2(\text{NNH}_2)(\text{PMe}_2\text{Ph})_3]$ produce ammonia in essentially similar yields to those obtained from the parent dinitrogen complexes, confirming the suggestion that they are the intermediates in the reduction. Similar treatment of $[\text{W}(\text{8-hq})(\text{NNH}_2)(\text{PMe}_2\text{Ph})_3]\text{X}$ (8-hqH \equiv 8-hydroxyquinoline) gives no ammonia but only hydrazine. Hydrazine is also produced upon treatment of the latter complexes with strong base alone, whereas for analogous Mo complexes only ammonia is formed in moderate yield. When treated with 40% KOH solution at 100 °C, the tungsten hydrazido(2–) complexes $[\text{WX}_2(\text{NNH}_2)(\text{PMe}_2\text{Ph})_3]$ (X \equiv Cl, Br or I) give ammonia and hydrazine in yields close to those obtained from the protonation reactions. The similar reaction of the parent dinitrogen complex $\text{cis-}[\text{W}(\text{N}_2)_2(\text{PMe}_2\text{Ph})_4]$, however, results in the loss of all the coordinated dinitrogen as gas. The solvent used in the protonation reactions of the dinitrogen complexes also effects the yields of ammonia and hydrazine and their ratio.

Protonation of the dinitrogen complexes beyond the NNH_2 stage has been reported to produce a hydrazido(–1)(NHNH_2) ligand:

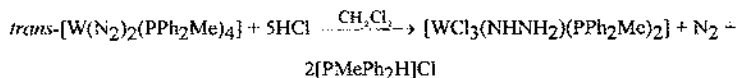

Similar complexes have been prepared by protonation of $\text{cis-}[\text{M}(\text{N}_2)_2(\text{PMe}_2\text{Ph})_4]$ or of the corresponding hydrazido(2–) complexes, $[\text{WX}_2(\text{NNH}_2)(\text{PMe}_2\text{Ph})_3]$ (X \equiv Cl or Br). Actually they turned out to be hydrides containing the $\text{WH}(\text{NNH}_2)$ fragment. These complexes give rather high yields of hydrazine on further acid treatment.

Treatment of dinitrogen complexes with strong acid is not necessary for ammonia formation. $\text{Cis-}[\text{W}(\text{N}_2)_2(\text{PMe}_2\text{Ph})_4]$ gives almost as high a yield of ammonia (1.7 mol/W atom) on treatment with methanol alone, either at reflux (3–5 h) or under tungsten filament irradiation (30 h at 20 °C). With ethanol, a lower yield is obtained

(0.4 mol per W atom), whereas the Mo analog gives very small yields with either alcohol.

Pickett and Talarmin [97b] have developed a cyclic system based on the complex *trans*-[W(N₂)₂(dppe)₂]. Protonation and further electrochemical reduction of the complexes yields ammonia with conservation of the W(dppe)₂ core. Under dinitrogen the initial complex is again recovered and the reaction cycle can be repeated on addition of an acid.

5.1.1.1. Kinetics and mechanism of protonation and reduction. The kinetics of protonation of *cis*-[M(N₂)₂(PMe₂Ph)₄] (M ≡ Mo or W) were investigated in methanol with an excess of acid which ultimately yields ammonia via complexes of the type [MX₂(NNH₂)(PMe₂Ph)₃] isolated when X ≡ Cl, Br or I [104]. Spectroscopic titration of a dilute solution of *cis*-[M(N₂)₂(PMe₂Ph)₄] with HX (X ≡ Cl, Br or HSO₄⁻) in methanol shows that, for a given metal, a common product is formed with all three acids, and that one mole-equivalent of acid is consumed per mole-equivalent of complex ([M] : [H⁺] = 1 : 1). The stoichiometry corresponds to the equation:

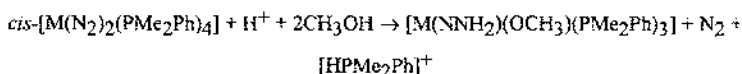

The kinetics of the reaction follow the first-order with respect to the complex concentration and the second order with respect to the concentration of acid, but they are independent of the nature of the anion: $k_{\text{Mo}}^{\text{app}} = 3.9(\pm 0.4) \times 10^5 [\text{H}^+] \text{ M}^{-2} \text{ s}^{-1}$ and $k_{\text{W}}^{\text{app}} = 3.6(\pm 0.4) \times 10^8 [\text{H}^+] \text{ M}^{-2} \text{ s}^{-1}$ at 25°C (k^{app} is the apparent rate constant).

These observations are consistent with the following mechanism [104]:

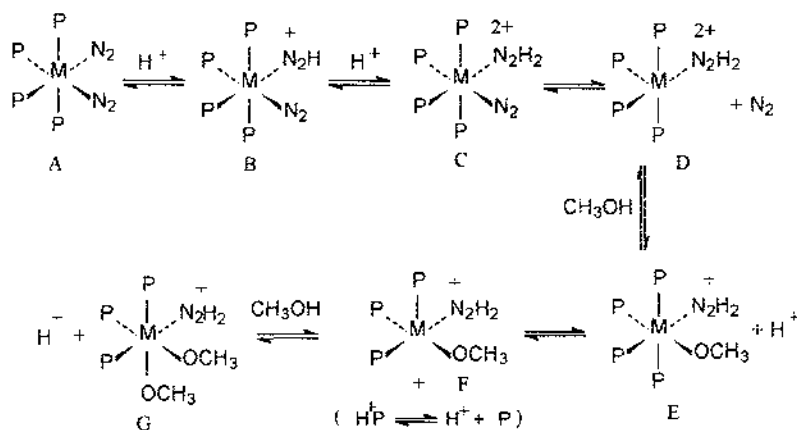

Diprotonation of a coordinated dinitrogen in *cis*-[M(N₂)₂(PMe₂Ph)₄] (A) labilizes the *cis*-dinitrogen to yield the five-coordinate intermediate [M(NNH₂)(PMe₂Ph)₄]²⁺ (D). Rapid attack of methanol on D yields *cis*-[M(NNH₂)(OCH₃)(PMe₂Ph)₄]⁺ (E) and a mole-equivalent of protons. Subsequent dissociation of a phosphine results in the five-coordinate

$[M(NNH_2)(OCH_3)(PMe_2Ph)_3]^+$ (F) which is rapidly attacked by methanol to yield $[M(NNH_2)(OCH_3)_2(PMe_2Ph)_3]$ (G) and a further mole-equivalent of protons. It is not clear whether loss of N_2 or PMe_2Ph is rate-limiting; however, the latter seem the more probable, and this is consistent with the kinetics if E is a steady-state intermediate.

It is of interest to note the much greater reactivity of *cis*- $[W(N_2)_2(PMe_2Ph)_4]$ compared with its Mo analog ($k_W/k_{Mo} = 9.2 \times 10^2$). This is a consequence of the greater basicity of dinitrogen coordinated to W. The isotope effect observed in the reaction of *cis*- $[Mo(N_2)_2(PMe_2Ph)_4]$, $k_H/k_D = 0.3$, is consistent with a mechanism involving proteolytic equilibria prior to the rate-limiting step. This mechanism shows that a protic solvent is advantageous for the protonation of coordinated dinitrogen in these complexes. The facile release of a proton upon coordination of a molecule of solvent is a process which is unique to protic solvents and has the result that protons are only consumed in the neutralization of liberated phosphine.

The reactions subsequent to the hydrazido(2-) stage depend upon the nature of the metal, the acid and the solvent used. For Mo, further protonation of the hydrazido(2-) intermediate gives in general 1 mol of ammonia and 0.5 mol of dinitrogen per Mo atom, resulting in formation of a Mo(III) product, pathway A [96]:

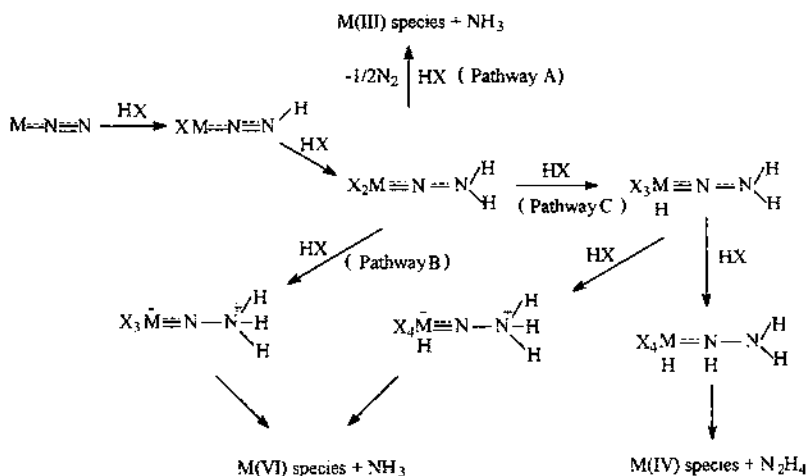

It is clear that the number of electrons of a single complex is insufficient to reduce N_2 to ammonia if Mo(III) is the product: and some disproportionation with another complex is necessary. In contrast, when W is the metal atom and H_2SO_4 is used as acid, the third protonation probably occurs at the outer nitrogen atom of the hydrazido(2-) ligand, giving 1 mol of ammonia per W atom together with tungsten nitride, which is further hydrolyzed by acid to produce another mole of ammonia. Thus all six electrons required to produce 2 mol of ammonia from dinitrogen come from W(0) which is oxidized to W(VI) (pathway B).

It would, of course, be presumptuous to claim that we could explain or even predict all the details of these results. Nevertheless, the results seem to agree with

general arguments on dinitrogen reactivity in the coordination sphere of transition metals, and they supplement well the picture of N_2 reduction in protic media in polynuclear complexes given in the previous section.

W(0) in its complexes is apparently the strongest reductant and possesses enough electrons to produce both hydrazine and ammonia. Co-ligands and the nature of the solvent largely determine the reaction selectivity. With stronger donors hydrazine is produced; we may compare this situation with dinitrogen reduction by polynuclear complexes in protic media at high pH, e.g. by $V(OH)_2$ - $Mg(OH)_2$ system. Hydrazido(2-) intermediate may be regarded as an analog of a binuclear MNNM complex with the same number of six d-electrons per complex.

The weaker are the co-ligands in the complex as donors, the weaker is the reducing power of the metal center. Such complexes prefer to use all six electrons (if they are available) to produce ammonia (rather than only four electrons to produce hydrazine). This behavior is reminiscent of the situation with a number of polynuclear systems in protic media which produce ammonia directly from coordinated dinitrogen (e.g. V(II)-catechol system) as well as in enzymatic N_2 reduction. For Mo(0) complexes, additional support is needed even to produce ammonia, and when $MoNNH_2$ is formed, another Mo complex is used as a reductant and is oxidized (producing free N_2). The situation with Mo(III) complexes in protic media is somewhat similar, since a stronger reducing agent is needed to reduce dinitrogen.

Among the most unexpected results is the reduction of dinitrogen with complexes in methanol solution without an added acid, albeit at somewhat higher temperatures. The base strength of dinitrogen at the coordination site is insufficient to be protonated by methanol. Probably, hydrogen bonds are initially formed which help to diprotonate N_2 replacing phosphine by CH_3O^- at the same time.

5.2. Protonation and reduction of dinitrogen in binuclear complexes [68,97,105,106]

Protonation of dinitrogen in mononuclear end-on complexes of the type $M-N\equiv N$ requires a low-valent electron-rich M with strong reducing properties. As already mentioned, catalytic systems based on this mechanism are unlikely, particularly for protic media; an even stronger reducing agent must be available to return M to its initial reduced state, and reactions with solvent protons will be difficult to avoid.

Binuclear complexes of the type $M-N\equiv N-M$ are an evident alternative; both M will share their electrons, and milder reducing agents could be expected to produce hydrazine or ammonia upon protonation. However, the first attempts to reduce bridging dinitrogen were disappointing. For example, in the binuclear complex $[(NH_3)_5RuN_2Ru(NH_3)_5]^{4+}$ dinitrogen does not seem to be more activated than in the mononuclear $[(NH_3)_5RuN_2]^{2+}$ complex. The NN bond vibration frequency in both complexes is virtually the same, and dinitrogen in the binuclear complex is neither protonated nor reduced, similar to the parent mononuclear complex. Unsuccessful attempts were also reported for other binuclear complexes of similar nature.

This is undoubtedly connected with the fact that the first complexes investigated were linear with a large number of d-electrons on each M (usually at least six).

According to theoretical analysis [13], they contain dinitrogen which is hardly more activated than in the corresponding mononuclear complexes, since when the number of d-electrons on each M is more than four the orbitals which are bonding with respect to NN bond and antibonding with respect to MN bonds are occupied. Thus, it could be expected that other binuclear complexes with a smaller number of d-electrons would be more promising as intermediates for dinitrogen reduction. However, experimental results on these were initially lacking or not convincing.

5.2.1. Complexes $[\{(\eta^5\text{-C}_5\text{H}_5)_2\text{TiR}\}_2\text{N}_2]$

As mentioned above, these complexes were the first intermediate complexes observed in N_2 reduction in solution. They are formed upon the interaction of Cp_2TiCl_2 or Cp_2TiCl ($\text{Cp} \equiv \eta^5\text{-C}_5\text{H}_5$) with RMgX in a dinitrogen atmosphere and can be observed at low temperatures. Thus, if the reaction of *i*-PrMgCl with Cp_2TiCl_2 is conducted at -60°C and then the temperature is lowered to -100°C , an intense blue color appears in the presence of N_2 (even at very low pressures of dinitrogen) [61,62]. The color disappears upon pumping of the dinitrogen, showing that the complex is very unstable. Spectrophotometric investigation [107] of the equilibrium



shows that the formation enthalpy is only approx. 5 kcal mol^{-1} . This unstable complex can be reduced to another complex, $\text{Cp}_2\text{Ti}(\text{MgCl})\text{NNTiCp}_2$ ($\nu_{\text{NN}} = 1100 \text{ cm}^{-1}$), when slowly reacting at -60°C with excess of reducing agent (*i*-PrMgCl). The complex may be regarded as a hydrazine derivative since it produces hydrazine in reaction with an acid, but also as an early example of a multicoordinated polynuclear complex with strongly activated dinitrogen. At higher temperatures, further reduction in the presence of *i*-PrMgCl leads to cleavage of the N–N bond and the formation of a nitride complex $\text{Cp}_2\text{TiN}(\text{MgCl})_2$ [108].

Comparatively stable dinitrogen complexes $(\text{Cp}_2\text{TiAr})_2\text{N}_2$ with an aryl (rather than an alkyl) group on the titanium were prepared and investigated by Teuben et al. [105]. The complexes are formed in the reaction of ArMgCl with Cp_2TiCl . Both alkyl and aryl complexes are diamagnetic, indicating electron coupling through bonding. Theoretical analysis [109] of the model complex $(\text{Cp}_2\text{TiH})_2\text{N}_2$ was carried out using the extended Hückel method. The Ti–N and N–N distances were assumed to be the same as in the $[(\text{C}_5\text{Me}_5)_2\text{Ti}]_2\text{N}_2$ complex (vide infra), i.e. 2.016 \AA and 1.16 \AA respectively. It is seen that the stable configuration of the complex corresponds to the flat unit C–Ti–NN–Ti–C with trans- or cis-configuration and small energy difference between the two. An MO diagram for both forms is presented in Fig. 18. The intense light absorption responsible for the blue color of the complex corresponds to the allowed transitions $a_1 \rightarrow b_2$ or $a_g \rightarrow b_u$ for the cis- and trans-forms respectively. More recent elaborate analysis confirmed this conclusion [110]. The X-ray study [105] of the single crystal of the complex $[\{\text{Ti}(\eta\text{-C}_5\text{H}_5)_2(p\text{-MeC}_6\text{H}_4)\}_2(\text{N}_2)]$ is in very good agreement with both the assumed data and results obtained. The N–N distance (1.162 \AA) shows that dinitrogen is more strongly activated than in mononuclear complexes with terminal dinitrogen, though each of the titanium atoms possesses only one d-electron. However, the dinitrogen ligand cannot be protonated,

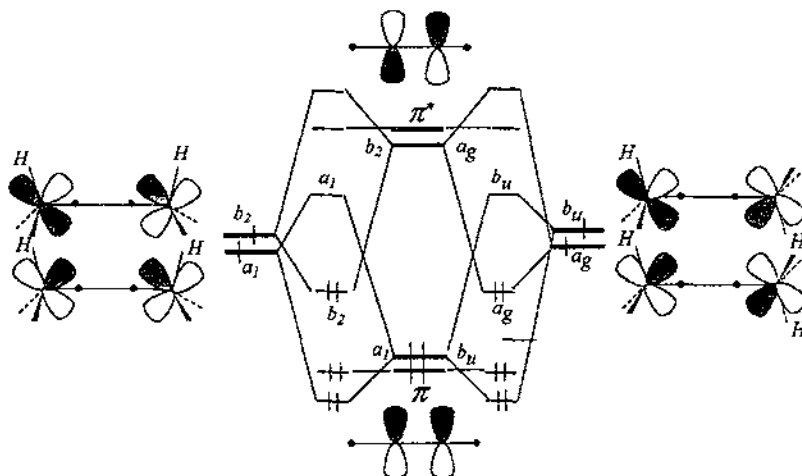

Fig. 18. MO diagram for cisoid and transoid configurations of the complex $(Cp_2TiH)_2N_2$.

evidently because the otherwise thermodynamically unfavorable diazene N_2H_2 would be formed. To reduce dinitrogen, more electrons have to be added to the complex to form a hydrazine derivative. Some less well characterized complexes with dinitrogen were reported in the systems $Cp_2TiCl_2 + MeMgI$ and $Cp_2TiCl_2 + K(\text{naphthalene})$ [52,105]. Bivalent titanium appears to be an active species forming complexes with N_2 .

5.2.2. Complexes with bivalent titanium and zirconium

Bercaw et al. have studied dinitrogen complexes with titanocenes and zirconocenes with permethylated cyclopentadienyl rings. $Ti(\eta^5-C_5Me_5)_2$ forms a binuclear complex with N_2 at $0^\circ C$ with linear bridging dinitrogen, as shown by X-ray structure determination [111]. The long N–N distance (1.160 Å) indicates activation of dinitrogen in the complex, but no protonation of the N_2 ligand to obtain hydrazine or ammonia was observed.

At low temperature ($-80^\circ C$) the titanium dinitrogen complex takes up additional dinitrogen

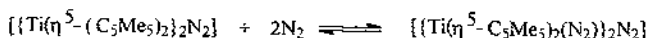

Presumably the complex contains two end-on N_2 molecules bound to titanium and one bridging dinitrogen, as follows from the similar zirconium complex with established structure (vide infra). In this case the titanium complex produces a nearly quantitative yield of hydrazine (in 1:1 ratio to the complex) when decomposed by HCl.

Permethylzirconocene forms a dinitrogen-containing complex with bridging and terminal dinitrogen ligands with the structure seen in Fig. 19 [112]. It reacts with HCl in toluene at $-80^\circ C$ to produce hydrazine (0.86 mol) according to the equation:

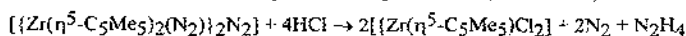

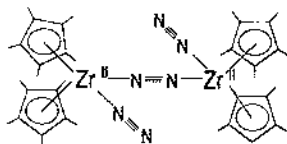

Fig. 19. Structure of the $\{[\pi\text{-C}_5(\text{CH}_3)_5]_2\text{Zr}(\text{N}_2)\}_2\text{N}_2$ complex.

A natural conclusion would be that it is bridging dinitrogen that is protonated and reduced, since according to the stretching frequencies and bond lengths the terminal dinitrogens are considerably less activated than the bridging one. However, a study of the reaction of HCl with the complex having terminal $^{15}\text{N}_2$ shows that half of the hydrazine is produced from terminal N_2 and the other half from the bridging dinitrogen [111]. The authors concluded that bridging N_2 was not protonated since, in particular, the related complex $[\{\text{Zr}(\eta^5\text{-C}_5\text{Me}_5)_2(\text{CO})\}_2\text{N}_2]$ did not give hydrazine on reaction with HCl [113]. According to the mechanism proposed, a terminal N_2 is protonated, then the other terminal ligand is lost and a symmetric bis-diazenido complex $[\text{Zr}(\eta^5\text{-C}_5\text{Me}_5)_2(\text{N}_2\text{H})_2]$ is formed. Further protonation of the latter gives diazene, which disproportionates to give dinitrogen and hydrazine.

The mechanism with intermediate N_2H_2 formation is by no means certain, however, and should be reconsidered, particularly in view of more recent data. There are definitely other alternatives. When HCl is added, there is a competition between the protonation of the ligating dinitrogen and the decomposition of the complexes with N_2 evolution due to their oxidation. Terminal dinitrogen ligands might increase complex stability, and that will help the protonation and reduction of dinitrogen which actually could be a bridging one. The results with terminal $^{15}\text{N}_2$ may be explained by postulating an exchange between the terminal and bridging dinitrogens and the absence of N_2 reduction in the carbonyl complex could be the result of the stronger electron-accepting properties of the CO ligands preventing the protonation of dinitrogen. In view of general theoretical expectations, the protonation of the bridging dinitrogen is perhaps more likely and Bercaw's results may be regarded in fact as the first examples of the protonation of N_2 in a well-defined bridging binuclear complex of titanium and zirconium with a d^2 electronic configuration.

Nevertheless, the mechanism proposed by the authors, and the absence of other definite results, led to the conclusion [105] even as late as in 1980 that "in dinuclear N_2 complexes with a linear M-N-N-M unit ($\text{M} \equiv \text{Ti, Zr}$), the ligated N_2 cannot be protonated directly despite the fact that the N-N distance is quite long and is intermediate between that found in free N_2 and MeN=NMe . On the other hand, terminal N_2 in Ti and Zr complexes may be just as reactive as in the other transition metal complexes...". This conclusion was definitely influenced by the spectacular results obtained by Chatt et al. described above.

5.2.3. Binuclear complexes with a single N_2 molecule, linear MNNM unit, and d^2 and d^3 electronic configuration of M

More recently, however, a new group of dinitrogen complexes appeared in the literature with N_2 being capable of both protonation and reduction. The complexes

are binuclear and contain dinitrogen only as a bridging ligand. Initially they were considered unusual, and they are sometimes still referred as a special case [97a], but their number is already quite considerable and continues to increase due to synthetic work of Churchill, Schrock, Henderson, Gambarotta, Floriani and others [104,114,115,117–119,127,129].

Sometimes the complexes can be synthesized directly from dinitrogen, in other cases they are prepared using hydrazine or its derivatives. For example, a complex $[\text{WCp}^*\text{Me}_3]_2\mu\text{-N}_2$ can be prepared with high yield by reduction of $\text{WCp}^*\text{Me}_3\text{OTf}$ with sodium amalgam in the presence of dinitrogen, while a similar Mo complex $[\text{MoCp}^*\text{Me}_3\text{OTf}]_2(\mu\text{-N}_2)$ was prepared by addition of hydrazine to $[\text{MoCp}^*\text{Me}_3(\text{OR})][\text{PF}_5]$ ($\text{Cp}^* \equiv \text{C}_5\text{Me}_5$, $\text{OTf} \equiv \text{OSO}_2\text{CF}_3$). The niobium complex $[\{\text{NbCl}_3(\text{THF})_2\}_2(\mu\text{-N}_2)]$ can be prepared in good yield by reaction of NbCl_5 with $(\text{Me}_3\text{Si})_2\text{NN}(\text{SiMe}_3)_2$ in dichloromethane in the presence of tetrahydrofuran. Many of the other similar dinitrogen complexes have been obtained by exchange of ligands, without touching dinitrogen; some are presented in Table 8. They include complexes of V(II), niobium(III), tantalum(III), Mo(IV) and W(IV). They all have metals with d^2 or d^3 electronic configurations. The MNNM unit in these complexes is usually very close to linear (Figs. 20 and 21). According to data on NN and MN bond lengths and NN vibration frequencies, dinitrogen is considerably more activated than in mononuclear and binuclear complexes with more reduced metals of the d^6 – d^8 electronic configurations.

For some complexes the NN bond is so elongated that the structure $\text{M}=\text{N}-\text{N}=\text{M}$ is more appropriate than the structure with an NN triple bond $\text{M}-\text{N}\equiv\text{N}-\text{M}$. They illustrate the four-electron mechanism of dinitrogen reduction discussed earlier. Moreover, the bridging dinitrogen ligand is often considered as N_2^{4-} donating its electrons to the metal atoms [118].

Table 8

X-ray crystallographic data for the homo binuclear dinitrogen complexes M–NN–M

Electronic configuration	Formula	Distances (Å)		Reference
		$r(\text{NN})$	$r(\text{MN})$	
d^1 – d^3	$[\{\text{Ti}^{\text{III}}(\text{C}_5\text{H}_5)_2(p\text{-MeC}_6\text{H}_4)\}_2\text{N}_2]$	1.16	1.96	[105]
	$[\{\text{Ti}^{\text{II}}(\text{C}_5\text{Me}_5)_2\}_2\text{N}_2]$	1.17	2.0	[111]
	$[\{\text{Zr}^{\text{II}}(\text{C}_5\text{Me}_5)_2(\text{N}_2)\}_2\text{N}_2]$	1.18	2.08	[112]
	$(\mu\text{-N}_2)\{[\sigma\text{-Me}_2\text{NCH}_2\text{C}_6\text{H}_4]_2\text{V}^{\text{II}}(\text{Py})\}_2(\text{THF})_2$	1.23	1.83	[114]
	$[\{\text{Nb}^{\text{III}}(\text{S}_2\text{CNET}_2)_3\}_2\text{N}_2]$	1.25	1.84	[115]
	$[\{\text{Ta}^{\text{III}}\text{Cl}_3(\text{PBr}_3)(\text{THF})\}_2\text{N}_2]$	1.28	1.80	[116]
	$[\{\text{Mo}^{\text{IV}}(\text{C}_5\text{Me}_5)\text{Me}_3\}_2\text{N}_2]$	1.24		[117]
	$[\{\text{W}^{\text{IV}}(\text{C}_5\text{Me}_5)\text{Me}_3\}_2\text{N}_2]$	1.33	1.76	[118]
	d^6 – d^{10}	$[\{\text{Mo}^0(\text{C}_6\text{H}_3\text{Me}_3)(\text{dmpe})\}_2\text{N}_2]$	1.15	2.04
$[\{\text{Ru}^{\text{II}}(\text{NH}_3)_5\}_2\text{N}_2]$		1.12	1.93	[120]
$[\{\text{Rh}^{\text{I}}\text{H}(\text{P}^i\text{Pr}_3)_2\}_2\text{N}_2]$		1.13	1.98	[121]
$[\{\text{Ni}^0(\text{PCy}_3)_2\}_2\text{N}_2]$		1.12	1.78	[122]

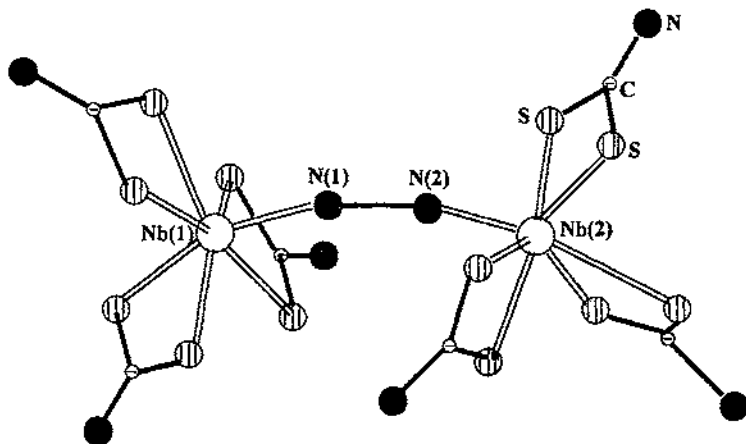

Fig. 20. A view of a molecule of $[\{\text{Nb}(\text{S}_2\text{CNEt}_2)_3\}_2](\mu\text{-N}_2)$ indicating the atomic numbering scheme. The ethyl groups have been omitted for clarity [115].

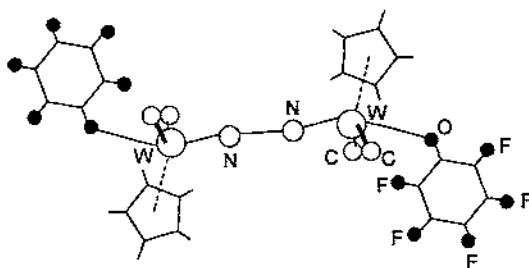

Fig. 21. A view of the structure of $[\text{WCp}^*\text{Me}_2(\text{OC}_6\text{F}_5)_2](\mu\text{-N}_2)$ [118].

Of particular interest to the content of this review is the mesityl V(II) complex with bridging dinitrogen prepared by Florani et al. [119]. The complex was synthesized by reduction of $[\text{V}(\text{mes})_3(\text{THF})]$ ($\text{mes} \equiv 2,4,6\text{-Me}_3\text{C}_6\text{H}_2$) by sodium metal under dinitrogen. The X-ray structure of the complex anion is presented in Fig. 22. It can be seen that the role of sodium is not only electron transfer (and reduction of V(III) to V(II)) in the complex, but also coordination of Na^+ between two of the aryl rings forming a cyclic complex with bridging N_2 . The complex bears a close resemblance to that proposed as an intermediate for N_2 reduction in the $\text{V}(\text{OH})_2\text{-Mg}(\text{OH})_2$ system (Section 4.2.1.1). There is definitely bonding between the Na^+ and nitrogen atoms in the dinitrogen bridge (Na-N distances are 2.55 and 2.63 Å). This shows that similar bonding (increasing the number of contacts with N atoms) can exist in polynuclear systems reducing N_2 in protic media (c.g. between N atoms and Mg^{2+} in the system mentioned). Moreover, this structure may throw some light on possible functions of the alkali metals in catalytic systems of ammonia synthesis described above (Section 4.1.2).

The results obtained upon protonation of the bridging dinitrogen confirm the

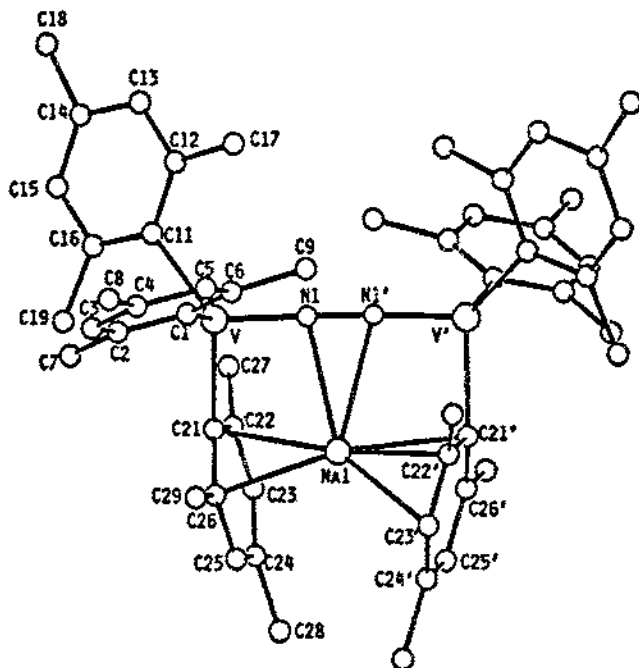

Fig. 22. A view of the anion in the dinitrogenmesitylvanadium complex [119].

conclusion that the dinitrogen ligand is strongly activated (Table 9). Niobium(III) and tantalum(III) complexes form hydrazine quantitatively when protonated by HCl or HBr. The kinetics of the reaction between Nb and Ta complexes and HX (HX=HCl or HBr) were investigated by Henderson et al. [106]. In most cases, the rate controlling step was found first to be protonation of bridging dinitrogen. This could be expected if protonation involves transformation of a complex into a hydrazine derivative. For one particular case, that of the tantalum complex reaction with HBr in acetonitrile, the reaction involves the rapid formation of the intermediate $[(Et_2NCl)_3Ta(\mu-NHNH_2)TaBr(S_2CNEt_2)_3]^{2+}$ which subsequently undergoes a rate controlling step of tantalum–nitrogen bond cleavage finally to yield N_2H_4 .

The V(II), Mo(IV) and W(IV) species (except for the V(II) mesityl complex) produce mainly ammonia upon protonation, the yields being less than quantitative: some of the coordinated dinitrogen is evolved as free N_2 . These differences in behavior can tentatively be reasonably explained in a similar way to N_2 reduction in protic media and in terminal dinitrogen complexes. Nb(III) and Ta(III) are sufficiently strong two-electron reductants to form hydrazine in four-electron reduction (cf. the reduction of N_2 in mononuclear W(0) complexes with the addition of strong donors, reduction in hydroxide systems in strongly alkaline media, and in catalytic systems in the presence of the sodium amalgam). In the case of most other complexes in Table 9 they are unable to produce hydrazine easily and have to receive two more electrons to break the NN bond and to produce ammonia. These additional

Table 9
Protonation of bridging dinitrogen complexes^a

Complex	N–N (Å)	Product and (yield) ^b (%)	Reference
[Zr(C ₅ Me ₅) ₂ (N ₂) ₂ (μ-N ₂) (μ-N ₂)][[<i>o</i> -Me ₂ NCH ₂)C ₆ H ₄] ₂ V(Py)] ₂ (THF) ₂	1.182(5) 1.228	N ₂ (67), N ₂ H ₄ (33) NH ₃ (33), V(III)	[112, 13] [114, 123]
[Nb(S ₂ CNEt ₂) ₃] ₂ (μ-N ₂)	1.25(2)	N ₂ H ₄ (100)	[115]
[Ta(S ₂ CNEt ₂) ₃] ₂ (μ-N ₂)		N ₂ H ₄ (100)	[115]
[Mo(C ₅ Me ₅)Me ₃] ₂ (μ-N ₂) with Zn(Hg)	1.236	NH ₃ (16) NH ₃ (32–36)	[117]
[Mo(C ₅ Me ₅)Me ₃](μ-N ₂)	1.235	NH ₃ (16)	[117]
[W(C ₅ Me ₅ Et)Me ₃ with Zn(Hg)]		NH ₃ (32–36)	
[W(C ₅ Me ₅)Me ₃] ₂ (μ-N ₂) with Na(Hg)		NH ₃ (17) NH ₃ (18)	[117]

^a HCl data. In the presence of Zn(Hg) or Na(Hg) lutidine–HCl or lutidine–HOSO₂CF₃ were used.

^b Based on total N₂ content.

electrons are provided by other dinitrogen complex molecules present in solution, and this results in the oxidation of the latter with free dinitrogen evolution. If the protonation is performed in the presence of another reducing agent (zinc or sodium amalgam) the yields of ammonia are considerably increased (see Table 9), since additional electrons are provided by the reductants and, therefore, less dinitrogen is lost from the complexes (cf. the reduction in Mo(0) mononuclear complexes, reduction in homogeneous and some heterogeneous protic media, and N₂ reduction in the enzymatic systems). Of course, the effectiveness of this transfer of additional electrons is determined by the organization of the contact between the active center and the reducing agent. In catalytic systems such as nitrogenase, or chemical model systems like those described above, this contact is evidently very effective. For these complexes under consideration, the yields do not reach 100% per coordinated N₂ and no catalysis is observed.

The result for the mesitylvanadium complex, which produces both hydrazine and ammonia as well as a lot of dinitrogen, may be explained by suggesting that HCl induces parallel protonation reactions with bridging N₂ and decomposition of the complex, which, being produced with two sodium atoms, is evidently a very strong reductant. Therefore, the ratio of N₂H₄, NH₃ and N₂ may reflect the ratio of rate constants of parallel reactions. Additional information is needed for more definite conclusions.

The reduction of dinitrogen upon protonation in specially prepared complexes may be considered a model of the second stage of dinitrogen reduction in solution in the stoichiometric and catalytic systems described above (Section 4.2), the first stage being the coordination of N₂. In this connection, it is of interest to compare metals (and their oxidation states) able to (a) activate dinitrogen to reduction in

protic media with (b) those able to form bridging binuclear MNNM complexes with N_2 undergoing reduction upon protonation:

(a) Ti(II) V(II) Cr(II) Nb(III) Mo(III) Ta(III)

(b) Ti(II) V(II) Zr(II) Nb(III) Mo(IV) Ta(III) W(IV)

The resemblance between both groups is striking and is hardly accidental. It supports the suggestion that metals of IV–VI groups with d^2 or d^3 electronic configuration, capable of activating and reducing dinitrogen in protic media, form linear intermediate MNNM complexes (usually bound to an additional electron donor, e.g. a metal cluster) in the reduction process, the final stage being protonation of the ligating dinitrogen. The choice between the two possible products, hydrazine and ammonia, is determined mainly by the M reducing ability: N_2H_4 is formed in the case of sufficiently strong reducing agents, while less strong reductants produce ammonia. Intermediate MNNM complexes in N_2 reduction in solution are of course much less stable than the model, specially prepared complexes, but they are no less active in N_2 reduction; rather the other way round, they contain more activated dinitrogen which can be reduced upon protonation even in alkaline media: apparently water is a sufficiently strong acid to protonate coordinated dinitrogen.

5.2.4. Bi- and polynuclear complexes of other types

Many similarities between dinitrogen reduction in protic media and N_2 reduction in the bridging dinitrogen in binuclear complexes with the linear MNNM unit seem to confirm that the optimum mechanism for dinitrogen reduction in protic media with comparatively mild reducing agents involves such complexes as the intermediates. It was tempting to try to spread this mechanism to all N_2 reductions in protic media, including also the biological nitrogen fixation, the more so, as two Mo atoms are present in the enzyme. One of the authors of this review (A.E. Sh.) supported this idea for a long time with the firm belief that two Mo atoms take part in a polynuclear reaction center. Now, it is clear that the mechanism of the enzymatic reduction does not involve the simultaneous participation of two Mo atoms in a complex with dinitrogen, although the conclusion about the polynuclear complex is evidently confirmed and a polyelectronic mechanism for N_2 reduction is more likely than ever.

Moreover, a linear binuclear MNNM unit is hardly an intermediate in enzymatic reduction taking into account the structure of the FeMo-cofactor of nitrogenase; with Fe atoms in the Fe(II) or Fe(III) state (d^6 or d^5 electronic configuration), such a complex is not a good candidate for an intermediate. Therefore, other types of complex must be considered as possible intermediates in the enzymatic process and in model systems.

The first example of the side-on binding mode of dinitrogen in a binuclear complex was reported for a nickel complex $\{[(PhLi)_3Ni]_2(OEt_2)_2\}_2N_2$, and subsequently $[Ph_5\{Na(OEt_2)\}_2(Ph_2Ni)_2N_2NaLi_6(OEt_2)_4OEt_2]_2$ [124]. There are several contacts of the coordinated dinitrogen with lithium ions, and a long N–N distance (1.35 Å) is reported indicating strong activation of dinitrogen. The first attempts to protonate dinitrogen in the complex were disappointing, but later conditions were found for protonation and reduction of coordinated N_2 . The products of the reaction are

ammonia (33%) and free dinitrogen [125]. The authors suggest intermediate formation of diazene and its further disproportionation, which agrees with the stoichiometry, but, as usual, formation of diazene is not the only alternative. Disproportionation may take place before liberating dinitrogen from the complex, and formation of ammonia may proceed in the complex at the expense of other complexes being oxidized producing dinitrogen. The transition metal, nickel, is not oxidized in the process of dinitrogen reduction and forms metallic nickel. The source of electrons is the phenyl rings forming diphenyl in the process of protonation.

Another complex with a very interesting coordination of dinitrogen was prepared by Pez et al. [126]. The authors investigated the dinitrogen reaction with a binuclear titanium metallocene complex, $[\mu-(\eta^1:\eta^5\text{-C}_5\text{H}_4)](\eta\text{-C}_5\text{H}_5)_3\text{Ti}_2$. Two molecules of the complex coordinate one dinitrogen; therefore, four titanium atoms are situated around one N_2 molecule. In hydrocarbon solvents a deep blue complex of composition $[\mu-(\eta^1:\eta^5\text{-C}_5\text{H}_4)](\eta\text{-C}_5\text{H}_5)_3\text{Ti}_2\text{N}_2$ is formed. Reaction with N_2 (10 atm) in 1,2-dimethoxyethane yields N_2 complex characterized by $\nu(\text{N-N})=1222\text{ cm}^{-1}$, one of the lowest N–N vibrational frequencies yet observed for a coordinated dinitrogen ligand. Reaction with N_2 in tetrahydrofuran produces a N_2 complex with $\nu(\text{N-N})=1296\text{ cm}^{-1}$. Successive treatment of the complex obtained in glime with THF–glime and bis(2-methoxyethyl) ether (diglime) gave a crystalline dinitrogen complex with $\nu(\text{NN})=1282\text{ cm}^{-1}$. Single crystal X-ray crystallography of the complex revealed that dinitrogen is simultaneously bound to three titanium atoms. The N_2 is σ -bonded to the one bivalent titanium atom in $[\mu-(\eta^1:\eta^5\text{-C}_5\text{H}_4)](\eta\text{-C}_5\text{H}_5)_3\text{Ti}_2$, and also to the two titanium atoms in $(\eta^5\text{-C}_{10}\text{H}_8)(\eta\text{-C}_5\text{H}_5)_2\text{Ti}_2$ in σ,π -mode, with one titanium bound in end-on and the other bound in side-on. As a result of multiple coordination, the N–N length (1.30 Å) is very much elongated when compared with free dinitrogen and many N_2 complexes. Treatment of the solution of the latter complex with dihydrogen gas or with dry hydrogen chloride, results in a loss of the coordinated dinitrogen as free N_2 . However, aqueous hydrolyses of the complex in diglime yields mostly ammonia. As usual, there is competition between complex decomposition with N_2 evolution and the protonation (and reduction) of ligating dinitrogen. Therefore, when free N_2 is formed, this could be both the consequence of weak dinitrogen activation and complex instability. However, since in one case at least, the complex yields ammonia upon hydrolysis, there is no doubt that dinitrogen is strongly activated. This result provides evidence for the activation of dinitrogen by means of multiple coordination facilitating the subsequent polyelectronic reduction upon protonation. For unstable dinitrogen complexes this is only possible when several metal ions are united by a common ligand(s) before coordinating N_2 .

5.2.5. Side-on dinitrogen coordination in titanium complexes

Unusual side-on configuration of the binuclear dinitrogen complexes with nickel could be explained by peculiarities of the complexes, particularly by participation of the lithium ions. More recent results indicate, however, that side-on binuclear dinitrogen complexes are not something very exotic. New examples of this type of configuration appeared recently in the literature.

The reaction of *trans*-(TMEDA) $_2\text{TiCl}_2$ with one equivalent of freshly sublimed

$(\text{Me}_3\text{Si})_2\text{NLi}$ in toluene under N_2 at -40°C , formed a complex $\{[(\text{Me}_3\text{Si})_2\text{N}]\text{TiCl}(\text{TMEDA})\}_2(\mu\text{-N}_2)$ **1** [127]. The structure of the complex was determined by X-ray analysis. The $\text{Ti}(\text{I})\text{-N}(4)\text{-N}(4a)$ angle is $168.5(2)^\circ$ and the N-N bond is strongly elongated with respect to N_2 (N-N bond distance is 1.289 \AA). The Ti-N distance with coordinated dinitrogen is very short (1.762 \AA).

The reaction of $\text{trans}-(\text{TMEDA})_2\text{TiCl}_2$ with 2.5 equivalents (instead of one) of $(\text{Me}_3\text{Si})_2\text{NLi}$ in the presence of a small excess of TMEDA led, under the same reaction conditions, to another stoichiometry:

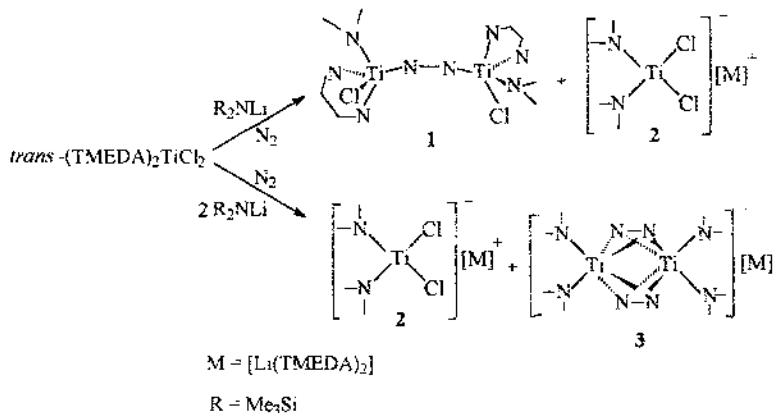

The reaction is actually a disproportionation, since from three molecules of bivalent titanium, one trivalent titanium complex is obtained with a binuclear dinitrogen complex of mixed valence ($\text{Ti}(\text{II})\text{-Ti}(\text{I})$). This complex **3** consists of two separate $[\text{Li}(\text{TMEDA})_2]$ and $\{[(\text{Me}_3\text{Si})_2\text{N}]_2\text{Ti}\}_2(\mu\text{-}\eta^2\text{-}\eta^2\text{-N}_2)_2$ ionic fragments. Four of the six coordination sites of titanium are occupied by four N atoms of two side-on coordinated coplanar dinitrogens. The N-N distance is very long (1.379 \AA) and significantly longer than in the complex **1**. Complex **1** is diamagnetic, while **3** is paramagnetic ($\mu_{\text{eff}} = 1.37 \mu_{\text{B}}$) since it contains an uneven number of electrons. The authors suggest that the difference in dinitrogen bonding mode can be only explained by steric bulk in the two complexes. Another reason could be that in **2**, titanium(I-II) in the anion is a stronger donor than titanium(II) in the neutral complex **1**. Therefore, a side-on complex may become preferable (see Section 2.3.3). In any case, it is clear that the energies of linear and side-on complexes are not very different for such types of complex, and, therefore, both types can be intermediates in dinitrogen reduction.

5.2.6. Complexes with flat $\text{M} \begin{array}{c} \diagup \text{N} \diagdown \\ | \\ \diagdown \text{N} \diagup \end{array} \text{M}$ unit

There are, so far, very few examples of such complexes. The first complex of this kind was obtained in crystalline form after slow crystallization of $(\text{C}_5\text{Me}_5)_2\text{Sm}$ from toluene, presumably under dinitrogen [128]. A quantitative yield of the complex

was obtained after a 4 week crystallization. The complex is $[(C_5Me_5)_2Sm]_2(\mu-\eta^2:\eta^2-N_2)$ and represents the first example of a planar, side-on bonding of two metals and dinitrogen. The X-ray structural investigation revealed that while the Sm–N and Sm–C distances are within a range typical for an eight-coordinate Sm(III) complex, the N–N bond distance is 1.088(12) Å, i.e. even shorter than in free dinitrogen (1.0975 Å). Perhaps this shortening is due to the X-ray measurement of a complex with dinitrogen rotation, but the value shows dinitrogen to be only weakly activated. When the complex is dissolved in toluene, an equilibrium is established:



The concentration of the complex increases at lower temperatures.

Another complex of this kind was obtained [129] with a Zr(II) compound and has a formula $\{[(i-Pr_2PCH_2SiMe_2)_2N]ZrCl\}_2(\mu-\eta^2:\eta^2-N_2)$. The structure of the complex is given in Fig. 23. It has flat configuration of the unit with an extremely long N–N distance, approx. 1.55 Å, i.e. almost 0.1 Å longer than in hydrazine. The complex produces 1 equivalent of hydrazine when decomposed by acid and is considered a compound of two Zr^{4+} with a bridging N_2^{4-} unit.

More recently, a third example of a complex with side-on bridging dinitrogen was reported having a flat $M-\overset{N}{\parallel}-M$ unit. This time it is of a quite different nature, the unit being part of the lithium dication. The complex was obtained by reaction of Cp_2ZrCl_2 with the product of the interaction between $PPhH_2$ and $n-BuLi$ [130]. A crystallographic study of the complex crystals revealed a salt containing a zirconium(III) dianion, $[Cp_2Zr(\mu-PPh)]_2^{2-}$ with a $[{(THF)_3Li}_2\mu-N_2]^{2+}$ dication. A crystallographically imposed center of symmetry relates the two pseudo-tetrahedral $Li(THF)_3$ fragments, which are bridged by a side-on N_2 moiety. The N–N distance in the cation (1.06(1) Å) is indistinguishable from that in free dinitrogen. Coordination of dinitrogen with two lithium cations is extremely unexpected, since dinitrogen is a very weak base and nucleophilic and does not usually interact with acids and electrophiles. Moreover, strong Coulombic repulsion would further weaken the bonding with lithium cations. It can be suggested, therefore, that the complex is actually a salt of the monoanion $[Cp_2Zr(\mu-PPh)]_2^-$ and monocation $[{(THF)_3Li}_2\mu-N_2]^+$; therefore, nitrogen is bound to Li_2^+ or two lithium cations are bound to N_2^- .

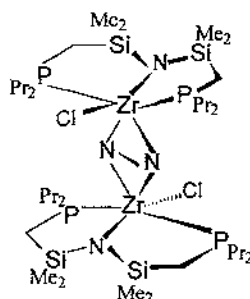

Fig. 23. Molecular structure of the complex $\{[(i-Pr_2PCH_2SiMe_2)_2ZrCl]_2\}(\mu-\eta^2:\eta^2-N_2)$ [129].

This would correspond to the reported extreme air-sensitivity of the complex. The complex exhibits an EPR signal which is attributed by the authors to the triplet state of the dianion. Further investigation is needed to clarify the nature of this remarkable species. (Another complex, $[\text{LiClLi}]^+ [\text{Cp}_2\text{Zr}(\mu\text{-PPh})_2]^-$ [136], was prepared for the same system under argon instead of dinitrogen. In this case, the unit charges of both cation and anion are beyond doubt. The X-ray structure of the complex revealed that the anion is apparently identical with the anion of the nitrogen containing complex; therefore, Li_2N_2 is indeed the monocation, and may be considered as N_2^- stabilized by two Li^+ cations.)

In summary, polynuclear complexes with a multicoordinated dinitrogen ligand likely to be the intermediate in catalytic N_2 reduction processes with mild reducing agents, including biological nitrogen fixation, can be formed via linear as well as side-on mono- and binuclear complexes with subsequent coordination of other metals. Our knowledge of possible intermediate dinitrogen complexes is still not sufficient to choose a priori between possible alternatives and new results show that the field is still in the process of active development.

5.2.7. Iron-dinitrogen complexes [131]

The X-ray structure of nitrogenase gives very strong support to the hypothesis that the mechanism of dinitrogen activation on the enzyme involves Fe atoms of the FeMo-cofactor, with Mo (or V) stabilizing the complex and/or perhaps optimizing its redox potential. Therefore, more attention should be paid to Fe complexes coordinating and reducing dinitrogen. An Fe catalyst for the conventional ammonia synthesis from dinitrogen involves a polynuclear Fe cluster. The catalysis requires high temperature; however, dihydrogen, the weakest reducing agents among those reacting with dinitrogen, can be used. There is no doubt that dinitrogen is activated in a side-on fashion and the structure of a surface dinitrogen complex forming a bridge between two Fe atoms has been proposed [132]. From what is known about nitrogen fixing systems, the conventional catalyst for ammonia synthesis still seems to be the closest analog of the nitrogenase active center, at least from the point of view of the nature of metal atoms involved in dinitrogen activation and reduction.

Fe complexes were mentioned in the section describing dinitrogen reduction in aprotic media. They reduce dinitrogen to nitrides with moderate yields with such reducing agents as RMgX and with almost 100% yield with lithium naphthalene. Dinitrogen reduction in protic media in the presence of Fe compounds was also found and described above.

$\text{Fe}(0)$, formed in the LiAr reduction of FeCl_3 , activates dinitrogen and reduces it upon protonation. The structures of Fe complexes active towards N_2 were elucidated [101].

Dinitrogen Fe complexes have been known for many years since Sacco and Aresta published their first paper [134] on mononuclear dinitrogen iron(II) hydride phosphine complexes. These and many similar complexes were found to be inactive in N_2 protonation and reduction, but later conditions were found to protonate a

dinitrogen Fe(0) phosphine complex with at least partial reduction to ammonia [102]. The tetraphenyliron(0) complex $[\text{FePh}_4][\text{Li}(\text{OEt}_2)_4]$ is also active towards N_2 producing a complex which yields N_2H_4 , NH_3 and N_2 upon protonation [133].

Another Fe complex which may be considered analogous with the FeMo-cofactor of nitrogenase is formed in the reaction of tetraphenyliron(II) dihydride in tetrahydrofuran [135]. A binuclear Fe(II) complex is formed (Fig. 24) which includes three $\mu_2\text{-H}$ and three $\mu_2\text{-Li}$ bridges; the Fe–Fe distance in the complex (2.4 Å) is very close to that in Fe metal and in the FeMo-cofactor.

Dinitrogen is coordinated by the complex with $\nu(\text{N}_2) = 1660 \text{ cm}^{-1}$ and is weakly bound: it is easily lost during crystallization. At the same time, dinitrogen can be reduced upon protonation producing hydrazine and free N_2 . It is of interest that the electrons to produce N_2H_4 are taken from Fe (and not from LiPh ligand as in the case of the similar nickel complex) since the amount of hydrazine formed corresponds to the Fe(II) \rightarrow Fe(III) transformation.

Since it became known that Fe–S-clusters are involved in nitrogenase, many Fe–S complexes have been synthesized in attempts to prepare models for the active center of the enzyme. Their activity towards dinitrogen is unknown, perhaps zero, but synthetic achievements are very significant. Some examples of the structures of these model complexes are shown in Fig. 25 [137–139]. Now, since the structure of the

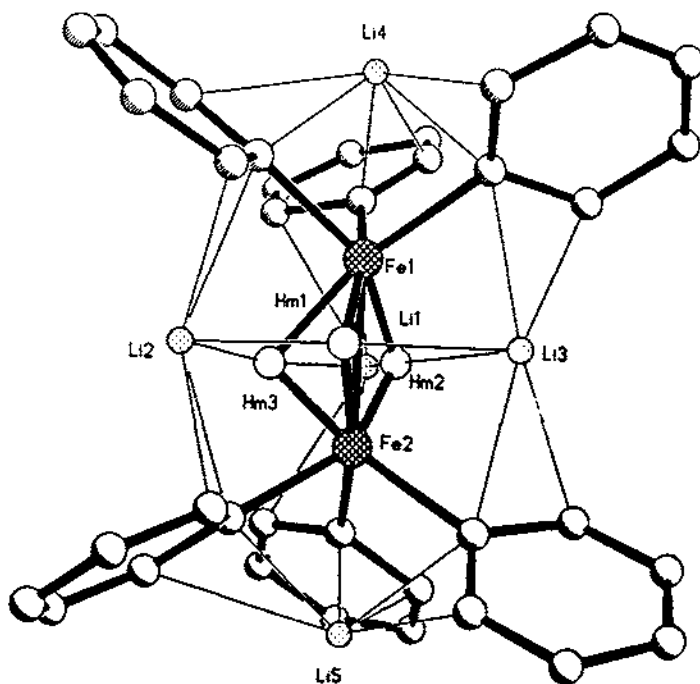

Fig. 24. Molecular structure of the complex $[\text{Ph}_3\text{Fe}(\mu_2\text{-H})_3\text{FePh}_3]\text{Li}_3 \cdot 5\text{THF}$; the THF molecules are omitted.

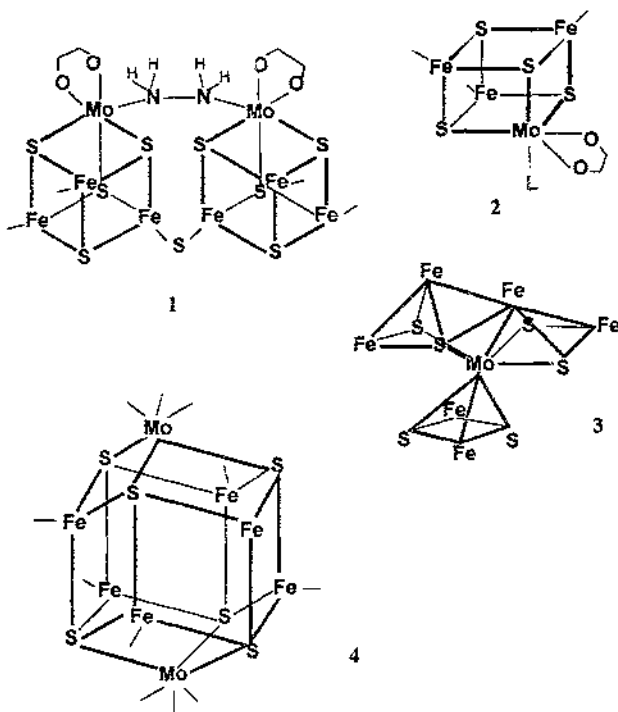

Fig. 25. The structures modelling aspects of the cofactor centers of nitrogenases: 1, the MoFeS core of double bridged double-cubane structure [137]; 2, MoFe₃S₄ cubane structure [138]; 3, the FeMoS core of [MoFe₆S₆(CO)₁₆]²⁻ [139]; 4, double-capped prismane [Fe₆S₆L₆{Mo(CO)₃]₂]ⁿ⁻ [137].

cofactor has been elucidated, this will presumably encourage synthetic chemists to prepare new complexes with structures closer to that of the cofactor.

6. Conclusions

Developments in the last thirty years in the low temperature chemistry of molecular nitrogen now include a number of systems acting in both aprotic and protic media, as well as quite a few dinitrogen complexes with transition metal compounds capable of reducing N₂ upon protonation. Each system can be characterized by its own properties, but some general characteristics may be formulated uniting all these systems including the nitrogenase complex.

In aprotic media, with strong reducing agents the reaction may proceed in a mono- or binuclear complex, e.g. M–N≡N–M with a full cleavage of one of the π-bonds. In protic media, with participation of comparatively weak reducing agents the reaction requires polynuclear systems, such as hydroxides of vanadium(II), niobium(III), tantalum(III), chromium(II) or polynuclear vanadium(II) complexes with catechols. Polynuclear Mo(III) complexes catalyze dinitrogen reduction with

stronger reducing agents, e.g. $\text{Ti}(\text{OH})_3$, or sodium amalgam. The reaction rate is higher if the same reducing agent functions with more polynuclear $\text{Mo}(\text{III})$ complexes. The nitrogenase cofactor, which seems to activate and reduce dinitrogen, and includes eight transition metal atoms (seven Fe and one Mo in classic nitrogenase; seven Fe and one V, or eight Fe, in alternative nitrogenases) is the most remarkable example of these polynuclear systems.

This phenomenon results from the peculiarities of the dinitrogen molecule: with the same reducing agent, a larger number of metals in the complex has an advantage as the catalyst for reduction, ensuring four- or six-electron reduction of dinitrogen to hydrazine or ammonia.

In the reduction of dinitrogen upon protonation in mononuclear complexes of W, Mo, V or Fe, four or six electrons are transferred from one metal ion, but one has to start from a zerovalent metal. It is not likely that this process can be catalytic in the presence of protons, since to return the metal to its initial zerovalent state requires a very strong reducing agent.

The reduction products in protic media are hydrazine or (and) ammonia; diazene N_2H_2 is not apparently an intermediate, either in the free or bound states. In model systems we have examples of all different selectivities: sole formation of ammonia (from N_2) and ethylene (from acetylene), formation of hydrazine (together with ammonia) and ethane (together with ethylene), and also formation of hydrazine only (without ammonia). The formation of hydrazine, activated in binuclear complexes, requires a sufficiently strong reducing agent. Hydrazine and ammonia are often produced in parallel reactions, though of course hydrazine may undergo further reduction. With a weaker reductant, the process may proceed directly to ammonia, but presumably through a hydrazine derivative.

This property reveals itself in both dinitrogen fixing systems in protic media and in specially prepared linear binuclear complexes capable of reducing dinitrogen upon protonation. Thus, upon protonation of dinitrogen in binuclear niobium(III) and tantalum(III) complexes, N_2 quantitatively produces hydrazine. In the case of weaker reductants ($\text{V}(\text{II})$, $\text{Mo}(\text{IV})$ and $\text{W}(\text{IV})$), dinitrogen waits for two additional electrons to cleave the NN bond and subsequent formation of ammonia. Other molecules of a dinitrogen complex may provide additional electrons (they are oxidized in this process producing free dinitrogen), or specially added reductants can serve as electron donors.

In enzymatic dinitrogen reduction these additional electrons are apparently provided by united P-clusters, which obtained them from the Fe-protein.

In chemical dinitrogen reduction in protic media, the reaction proceeds mainly in the presence of complexes of those transition metals which are able to form binuclear dinitrogen complexes producing hydrazine or ammonia upon protonation. The d^2 – d^4 electronic configurations are optimum for metals in these binuclear complexes. This leads to the conclusion that similar complexes are intermediates in dinitrogen reducing systems in protic media with intermediates too unstable to be isolated and investigated. Most active systems based on the complexes of $\text{V}(\text{II})$ and $\text{Mo}(\text{III})$ belong to this category, including the catalytic systems based on Mo, complexes which, so far, are the only nonbiological catalytic systems reducing dinitrogen at

room temperature and atmospheric pressure. Presumably, the binuclear linear complexes $M-N\equiv N-M$ with a d^2-d^4 electronic configuration sufficiently activate dinitrogen for reduction under the action of protons. It is not excluded, however, that more contacts with dinitrogen are present in polynuclear systems activating N_2 . Few complexes are known so far with more than two contacts, but it may be that in a

three- or four-nuclear complex, such as $M-N\equiv N-M$  N_2 will be more activate than in binuclear complexes. For side-on activation of dinitrogen in binuclear complexes, the optimum number of d-electrons on M can obviously exceed that for linear end-on complexes.

Although the problem of the site of N_2 activation by nitrogenase has not been finally resolved, the cofactor structure revealed by X-ray structural analysis seems to be more suitable for activation of N_2 on the central coordinately unsaturated Fe atoms than on the fully saturated Mo atom or in the binuclear FeN_2Mo complex. The role of Mo and its replacement by V consists probably in stabilization of the cluster, which is revealed in the shorter Fe–Fe distances at the side closest to Mo.

If the hypothesis that the activation and reduction of dinitrogen proceeds on four central Fe atoms is correct, then the intermediate complex may include four Fe

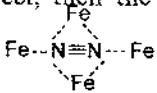
atoms, and the structure  can be suggested. A further step will be the formation of a hydrazine derivative. The subsequent protonation and NN bond cleavage, possibly with participation of two more central Fe atoms (in a sequence which is still not clear), will lead to the formation of ammonia.

We now know several examples of perpendicular coordination of dinitrogen in binuclear complexes, of the type $M \begin{matrix} N \\ || \\ N \end{matrix} M$, with a strongly activated N_2 molecule. Four contacts with Fe atoms in the complex would strongly activate dinitrogen.

Finally, the suggested mechanism of dinitrogen reduction on the cofactor may be reminiscent of the classic Haber ammonia synthesis. Presumably the activation of N_2 starts with formation of the bridging dinitrogen with perpendicular π -coordination relative to the surface Fe atoms. Although a high temperature process, it requires the weakest possible reductant, dihydrogen, which evidently forms a surface hydride. The difference in activation energy is understandable, taking into account the less than optimal arrangement of surface Fe atoms when compared with the sophisticated cofactor structure.

Certainly, any analogy must not be spread too far. Sulfides, which are ligands in the cofactor, are known to be a powerful catalytic poison of the heterogeneous catalyst. However, this merely demonstrates the affinity of the sulfides to Fe. In the nitrogenase, sulfides do not enter the active center but are themselves part of the catalytic molecular system.

New synthetic strategies may follow clarification of the structure of nitrogenase, and new synthetic analogs of the cofactor will certainly be prepared. We may expect that some of them will be active catalysts for dinitrogen reduction, including perhaps new catalysts for catalytic ammonia synthesis from molecular nitrogen and hydrogen.

Acknowledgments

The research described in this publication was made possible in part by Grant No. RETOOO from the International Science Foundation and Grant No. 93-04-7252 from the Russian Foundation of Fundamental Research.

References

- [1] G. Henrice-Olivé and Olivé, in R.W.F. Hardy, F. Bottomley and R.C. Burns (eds.), *A Treatise on Dinitrogen Fixation*, Wiley, New York, 1979, p. 3.
- [2] V.N. Kondratiev (ed.), *Bond Dissociation Energies. Ionization Potentials and Electron Affinity*, Nauka, Moscow, 1974 (in Russian).
- [3] S.G. Lias, J.E. Bartness, J.F. Liebman, J.L. Holmes, R.D. Levik and W.G. Mallard, *J. Phys. Chem.*, (Ref. data) 17 suppl. no. 1 (1988).
- [4] B. Rucic and J. Berkourtz, *J. Phys. Chem.*, 95 (1991) 4378.
- [5] A.E. Shilov, in R.W.F. Hardy, F. Bottomley and R.C. Burns (eds.), *A Treatise on Dinitrogen Fixation*, Wiley, New York, 1979, p. 31.
- [6] K.P. Huber and G. Herzberg, *Molecular Spectra and Molecular Structure. IV. Constants of Diatomic Molecules*, Doorecht, New York, 1970.
- [7] M.L. McKee, M.E. Squillacote and D.M. Stanbury, *J. Chem. Phys.*, 96 (1992) 3266.
- [8] J.A. Pople and L.A. Curtiss, *J. Chem. Phys.*, 95 (1991) 4385.
- [9] G.I. Likhtenshtein and A.E. Shilov, *Zh. Fiz. Khim.*, 44 (1970) 849 (in Russian).
- [10] Yu.G. Borod'ko and A.E. Shilov, *Usp. Khim.*, 38 (1969) 761 (in Russian).
- [11] P. Pelikan and R. Boza, *Coord. Chem. Rev.*, 55 (1984) 55.
- [12] E.I. Stiefel and G.N. George, in I. Bertiny, H.B. Gray, S. Lippard and J. Valentine (eds.), *Bioinorganic Chemistry*, University Science Books, Mill Valley, California, 1994, p. 365.
- [13] I.M. Treitel, M.T. Float, R.E. Marsh and H.B. Gray, *J. Am. Chem. Soc.*, 91 (1969) 6512.
- [14] K.I. Goldberg, D.M. Hoffmann and R. Hoffmann, *Inorg. Chem.*, 21 (1982).
- [15] H. Bothe, F.J. de Bruijn and W.E. Newton (eds.), *Nitrogen Fixation: Hundred Years After*, Proc. 7th Int. Congress on Nitrogen Fixation, Gustav Fisher, Stuttgart, 1988.
- [16] J.P.W. Young, in G. Stasey, R.H. Burris and H.J. Evans (eds.), *Biological Nitrogen Fixation*, Chapman and Hall, New York, 1992, p. 43.
- [17] V.K. Shah and W.J. Brill, *Proc. Nat. Acad. Sci. USA*, 74 (1977) 3249.
- [18] J. Kim and D.C. Rees, *Nature*, 360 (1992) 553.
- [19] M.M. Georgiadis, H. Komiya, P. Chakrabarti, D. Woo, J.J. Kornuc and D.C. Rees, *Science*, 257 (1992) 1653.
- [20] (a) J. Kim and D.C. Rees, *Science*, 257 (1992) 1677; (b) J. Kim and D.C. Rees, *Biochemistry*, 33 (1994) 389.
- [21] W.E. Newton, in R. Palacios, J. Mora and W.E. Newton (eds.), *New Horizons in Nitrogen Fixation*, Kluwer, Dordrecht, Netherlands, 1993, p. 5.
- [22] B.E. Smith and R.R. Eady, *Eur. J. Biochem.*, 205 (1992) 1.
- [23] J.R. Chisnell, R. Premakumar and P.E. Bishop, *J. Bacteriol.*, 170 (1988) 27.
- [24] J.B. Howard et al., *J. Biol. Chem.*, 264 (1989) 11270.
- [25] M.K. Chan, J. Kim and D.C. Rees, *Science*, 260 (1993) 792.
- [26] R.G. Lowery, C.L. Davis, M.-C. McKenna, P.J. Stephens and P.W. Ludden, *Biochemistry*, 28 (1989) 1206.
- [27] A. Willig and G.B. Howard, *J. Biol. Chem.*, 265 (1990) 6596.
- [28] B.J. Hales, E.E. Case, J.E. Morningstar, M.F. Dzeda and L.A. Mauterer, *Biochemistry*, 25 (1986) 7251.
- [29] R.D. Joerger, T.M. Loveless, R.N. Pau, L.A. Mitchenall, B.H. Simon and P.E. Bishop, *J. Bacteriol.*, 172 (1990) 3400.

- [30] (a) J.T. Bolin, A.E. Ronco, L.E. Mortenson, T.V. Morgan, M. Williamson and N.-H. Xuong, in P.M. Gresshoff, L.E. Roth, G. Stacey and W.E. Newton (eds.), *Nitrogen Fixation: Achievements and Objectives*, Chapman and Hall, New York, 1990, p. 117; (b) J.T. Bolin, N. Campobasso, S.W. Muchmore, W. Minor, T.V. Morgan and L.E. Mortenson, in R. Palacios, J. Mora and W.E. Newton (eds.), *New Horizons in Nitrogen Fixation*, Kluwer, Dordrecht, Netherlands, 1993, p. 89.
- [31] B.K. Burgess, *Chem. Rev.*, 90 (1990) 1377.
- [32] W.E. Newton, in G. Stacey, R.H. Burris and H.J. Evans, (eds.), *Biological Nitrogen Fixation*, Chapman and Hall, New York, 1992, p. 877.
- [33] T.R. Hoover, A.D. Robertson, R.L. Cerny, R.N. Hayes, J. Imperial, V.K. Shah and P.W. Ludden, *Nature*, 329 (1987) 855.
- [34] D.J. Scott, H.D. May, W.E. Newton, K.E. Brigle and D.R. Dean, *Nature*, 343 (1990) 188.
- [35] B.E. Smith, in P.M. Gresshoff, L.E. Roth, G. Stacey and W.E. Newton (eds.), *Nitrogen Fixation: Achievements and Objectives*, Chapman and Hall, New York, 1990, p. 3.
- [36] S.D. Conradson, B.K. Burgess, W.E. Newton, A. Di Cicco, A. Filipponi, Z.Y. Wu, C.R. Natoli, B. Hedman and K.O. Hodgson, *Proc. Nat. Acad. Sci. USA*, 91 (1994) 1290.
- [37] B.E. Smith, P.E. Bishop, R.A. Dixon, R.R. Eady, W.A. Filler, D.J. Lowe, A.J.M. Richards, A.J. Thomson, R.N.F. Thorneley and J.R. Postgate, in H.J. Evans, P.J. Bottomley and W.E. Newton (eds.), *Nitrogen Fixation Research Progress*, Martinus Nijhoff, Dordrecht, 1985, p. 597.
- [38] D.J. Evans, R.A. Henderson and B.E. Smith, in J. Reedijk (ed.), *Bioinorganic Catalysis*, Marcel Dekker, New York, 1993, Chapter 5, p. 89.
- [39] S.D. Conradson, B.K. Burgess, S.A. Vaughn, A.L. Roc, B. Hedman, K.O. Hodgson and R.H. Holm, *J. Biol. Chem.*, 264 (1989) 15967.
- [40] J. Scott et al., *J. Biol. Chem.*, 267 (1992) 20002.
- [41] R.R. Eady, M.E. Eldridge and M.J. Dilworth, in R. Palacios, J. Mora and W.E. Newton (eds.), *New Horizons in Nitrogen Fixation*, Kluwer, Dordrecht, Netherlands, 1993, p. 134.
- [42] D.J. Lowe and R.N.F. Thorneley, *Biochem. J.*, 215 (1983) 393.
- [43] D.J. Lowe and R.N.F. Thorneley, *Biochem. J.*, 224 (1984) 895.
- [44] D.J. Lowe, K. Fisher, R.N. Pau and R.N.F. Thorneley, in R. Palacios, J. Mora and W.E. Newton (eds.), *New Horizons in Nitrogen Fixation*, Kluwer, Dordrecht, Netherlands, 1993, p. 95.
- [45] C.C. Moser, *Nature*, 355 (1992) 786.
- [46] S.Yu. Druzhinin, L.A. Syrtsova, A.M. Uzenskaja and G.I. Likhtenstein, *Biochem. J.*, 290 (1993) 637.
- [47] R.C. Burns and R.W.F. Hardy, *Methods Enzymol. B*, 24 (1972) 480.
- [48] W.H. Orme-Johnson, *Science*, 257 (1992) 1639.
- [49] H. Deng and R. Hoffmann, *Angew. Chem., Int. Ed. Engl.*, (1993) 1062.
- [50] M.E. Vol'pin and V.B. Shur, *Dokl. Akad. Nauk. SSSR*, 156 (1964) 1102, (in Russian).
- [51] M.E. Vol'pin, V.B. Shur and M.A. Ilatovskaya, *Izv. Akad. Nauk. SSSR, Ser. Khim.*, (1964) 1728 (in Russian).
- [52] A.E. Shilov, in R.W.F. Hardy, F. Bottomley and R.C. Burns (eds.), *A Treatise on Dinitrogen Fixation*, Wiley, New York, 1979, p. 31.
- [53] M.E. Vol'pin and V.B. Shur, in J. Chatt, L.M. da Camara Pina and R.L. Richards (eds.), *New Trends in the Chemistry of Nitrogen Fixation*, Academic Press, London, 1980, p. 67.
- [54] M.E. Vol'pin and V.B. Shur, *J. Organomet. Chem.*, 200 (1980) 319.
- [55] V.B. Shur, Thesis, Moscow, 1989 (in Russian).
- [56] M.N. Bochkarev, A.A. Trifonov, G.A. Razuvaev, M.A. Ilatovskaya, V.B. Shur and M.E. Vol'pin, *Dokl. Akad. Nauk. SSSR*, 295 (1987) 1381 (in Russian).
- [57] L.G. Bell and H.H. Brintzinger, *J. Am. Chem. Soc.*, 92 (1970) 4464.
- [58] A. Ozaki and K. Aika, in R.W.F. Hardy, F. Bottomley and R.C. Burns (eds.), *A Treatise on Dinitrogen Fixation*, Wiley, New York, 1979, p. 169.
- [59] V.B. Shur, S.M. Iunusov and M.E. Vol'pin, *Dokl. Akad. Nauk. SSSR*, 277 (1984) 884 (in Russian).
- [60] E.E. van Tamelen and H. Rudler, *J. Am. Chem. Soc.*, 92 (1970) 5253.
- [61] A.E. Shilov, A.K. Shilova and E.F. Kvashina, *Kinet. Katal.*, 10 (1969) 1402 (in Russian).
- [62] A.E. Shilov and A.K. Shilova, *Zh. Fiz. Khim.*, 44 (1970) 288 (in Russian).
- [63] E.E. van Tamelen, R.B. Fechter and S.W. Scheller, *J. Am. Chem. Soc.*, 91 (1969) 7196.

- [64] B. Lorenz, G. Mobius, S. Rummel and M. Wahren, *Z. Chem.*, 15 (1975) 241.
- [65] (a) A.E. Shilov, in J. Chatt, L.M. da Camara Pina and R.L. Richards (eds.), *New Trends in the Chemistry of Nitrogen Fixation*, Academic Press, London, 1980, p. 130; (b) A.E. Shilov, in M. Gratzel (ed.), *Energy Resources through Photochemistry and Catalysis*, Academic Press, 1983, p. 535.
- [66] A.E. Shilov, *J. Molec. Catal.*, 41 (1987) 221.
- [67] A.E. Shilov, in J.A. Thomas and K.I. Zamaraev (eds.), *Perspectives in Catalysis*, Blackwell, 1992, p. 169.
- [68] A.E. Shilov, *Pure Appl. Chem.*, 64 (1992) 1409.
- [69] N.T. Denisov, V.F. Shuvalov, N.I. Shuvalova, A.K. Shilova and A.E. Shilov, *Kinet. Katal.*, 11 (1970) 813 (in Russian); A.E. Shilov, N.T. Denisov, O.N. Efimov, V.F. Shuvalov, N.I. Shuvalova and A.K. Shilova, *Nature*, 231 (1971) 460.
- [70] (a) Y.G. Borod'ko, O.N. Efimov, V.B. Panov and A.E. Shilov, *Zh. Fiz. Khim.*, 45 (1971) 248 (in Russian); (b) Y.G. Borod'ko, I.N. Ivleva, V.B. Panov and Yu.M. Shulga, *Zh. Fiz. Khim.*, 47 (1973) 1374 (in Russian); (c) N.T. Denisov, N.I. Shuvalova and A.E. Shilov, *Kinet. Katal.*, 35 (1994) 758 (in Russian).
- [71] L.A. Nikonova, A.G. Ovcharenko, O.N. Efimov, V.A. Avilov and A.E. Shilov, *Kinet. Katal.*, 8 (1972) 1602 (in Russian).
- [72] S.A. Isaeva, L.A. Nikonova and A.E. Shilov, *Nouv. J. Chim.*, 5 (1981) 21.
- [73] J.Y. Becker and B. Posin, *J. Electroanal. Chem.*, 250 (1988) 385.
- [74] B. Folkesson and R. Larsson, *Acta Chem. Scand. Ser. A.*, 33 (1979) 347.
- [75] N.P. Luneva, A.P. Moravsky and A.E. Shilov, *Nouv. J. Chim.*, 6 (1982) 245.
- [76] S.R. Cooper, Yu.B. Koh and K.N. Raymond, *J. Am. Chem. Soc.*, 104 (1982) 5092.
- [77] N.P. Luneva, S.A. Mironova, A.E. Shilov, M.Yu. Antipin and Yu.T. Struchkov, *Angew. Chem., Int. Ed. Engl.*, 32 (1993) 1178.
- [78] N.T. Denisov and N.I. Shuvalova, *React. Kinet. Catal. Lett.*, 4 (1976) 431.
- [79] L.P. Didenko, O.K. Gavrilina, E.E. Yablonskaya, A.K. Shilova and A.E. Shilov, *Nouv. J. Chim.*, 7 (1983) 605.
- [80] L.P. Didenko, A.B. Gavrilov, A.K. Shilova, V.V. Strelets, V.N. Tsarev, A.E. Shilov, V.D. Makhaev, A.K. Banerjee and L. Pospishil, *Nouv. J. Chim.*, 10 (1986) 584.
- [81] A.K. Shilova, V.V. Strelets, L.P. Didenko and A.E. Shilov, *Kinet. Katal.*, 28 (1987) 1239 (in Russian).
- [82] O.N. Efimov, A.K. Shilova, A.E. Shilov and V.B. Makhaev, *Kinet. Katal.*, in press (in Russian).
- [83] M.Yu. Antipin, Yu.T. Struchkov, A.E. Shilov and A.K. Shilova, *Gazz. Chim. Ital.*, 123 (1993) 265.
- [84] N.T. Denisov, N.I. Shuvalova and A.E. Shilov, *Kinet. Katal.*, 34 (1993) 858 (in Russian).
- [85] A.V. Gorodyskii, V.V. Danilin, O.N. Efimov, N.E. Nechaeva and V.N. Tsarev, *React. Kinet. Catal. Lett.*, 11 (1979) 337.
- [86] G.V. Nikolaeva, S.I. Kulakovskaya, O.N. Efimov and A.E. Shilov, *Kinet. Katal.*, 26 (1985) 473 (in Russian).
- [87] A.D. Allen and C.V. Senoff, *Chem. Commun.*, (1965) 621.
- [88] A.E. Shilov, A.K. Shilova and Yu.G. Borod'ko, *Kinet. Katal.*, 7 (1966) 768 (in Russian).
- [89] D.F. Harrison and H. Taube, *J. Am. Chem. Soc.*, 89 (1967) 5706.
- [90] F. Bottomley, in R.W.F. Hardy, F. Bottomley and R.C. Burns (eds.), *A Treatise of Dinitrogen Fixation*, Wiley, New York, 1979, p. 109.
- [91] A.J.L. Pombeiro, in J. Chatt, L.M. da Camara Pina and R.L. Richards (eds.), *New Trends in the Chemistry of Nitrogen Fixation*, Academic Press, London, 1980, p. 153.
- [92] M. Hidai, K. Tominari, Y. Uchida and A. Misono, *Chem. Commun.*, (1969) 814; M. Hidai, K. Tominari, Y. Uchida and A. Misono, *Chem. Commun.*, (1969) 1392.
- [93] J. Chatt, *J. Organomet. Chem.*, 100 (1975) 17.
- [94] J. Chatt, J.R. Dülworth and R.L. Richards, *Chem. Rev.*, 78 (1978) 589.
- [95] R.L. Richards, in J. Chatt, L.M. da Camara Pina and R.L. Richards (eds.), *New Trends in the Chemistry of Nitrogen Fixation*, Academic Press, London, 1980, p. 153.
- [96] M. Hidai, *Reactions of dinitrogen complexes: dinitrogen-reducing model systems*, in T.G. Spiro (ed.), *Molybdenum Enzymes*, Wiley, 1985, p. 285.
- [97] (a) G.J. Leigh, *Acc. Chem. Res.*, 25 (1992) 177; (b) C.J. Pickett and J. Talarmin, *Nature*, 317 (1985) 652.

- [98] J. Chatt, G. A. Heath and G.J. Leigh, *J. Chem. Soc. Chem. Commun.*, (1972) 444.
- [99] J. Chatt, A.J. Pearman and R.L. Richards, *J. Chem. Soc. Dalton Trans.*, (1977) 1853.
- [100] D. Rehder, C. Woitha, W. Priebsch and H. Gailus, *J. Chem. Soc. Chem. Commun.*, (1992) 364.
- [101] R.A. Forder and K. Prout, *Acta Crystallogr. Sect. B*, 30 (1974) 3778.
- [102] G.J. Leigh and Jimenez-Tenorio, *J. Am. Chem. Soc.*, 113 (1991) 5862.
- [103] J.A. Baumann and T.A. George, *J. Am. Chem. Soc.*, 102 (1980) 6153.
- [104] R.A. Henderson, *J. Organomet. Chem.*, 208 (1981) C51.
- [105] J.H. Teuben, in J. Chatt, L.M. da Camara Pina and R.L. Richards (eds.), *New Trends in the Chemistry of Nitrogen Fixation*. Academic Press, London, 1980, p. 233.
- [106] R.A. Henderson, *Transition Met. Chem.*, 15 (1990) 330.
- [107] Yu.G. Borod'ko, E.F. Kvashina, V.B. Panov and A.E. Shilov, *Kinet. Katal.*, 14 (1973) 255.
- [108] A.E. Shilov, A.K. Shilova, E.F. Kvashina and T.A. Vorontsova, *Chem. Commun.*, (1971) 1590.
- [109] R. Hoffmann, D.L. Thorn and A.E. Shilov, *Koord. Khim.*, 3 (1977) 1260 (in Russian).
- [110] V.N. Borslakh, Thesis, Chernogolovka, 1992.
- [111] R.D. Sanner, D.M. Duggan, T.C. McKenzie, R.E. Marsh and J.E. Bercaw, *J. Am. Chem. Soc.*, 98 (1976) 8358.
- [112] J.M. Manriquez, R.D. Sanner, R.E. Marsh and J.E. Bercaw, *J. Am. Chem. Soc.*, 98 (1976) 8351.
- [113] J.M. Manriquez, R.D. Sanner, R.E. Marsh and J.E. Bercaw, *J. Am. Chem. Soc.*, 98 (1976) 3042.
- [114] J.H. Edema, A. Meetsma and S. Gambarotta, *J. Am. Chem. Soc.*, 111 (1989) 6878.
- [115] J.R. Dilworth, R.A. Henderson, A. Hills, D.L. Hughes, C. Macdonald, A.N. Stephens and M. Walton, *J. Chem. Soc. Dalton Trans.*, (1990) 1077.
- [116] M.R. Churchill and Wasserman, *Inorg. Chem.*, 20 (1981) 2899.
- [117] R.R. Schrock, R.M. Kolodziej, A.H. Liu, W.M. Davis and M.G. Vale, *J. Am. Chem. Soc.*, 112 (1990) 4338.
- [118] M.R. Churchill and Y.-J. Li, *J. Organomet. Chem.*, 301 (1986) 49.
- [119] R. Ferguson, E. Solari, C. Floriani, A. Chiesi-Villa, and C. Rizzoli, *Angew. Chem. Int. Ed. Engl.*, 32 (1993) 396.
- [120] I.M. Trietel, M.T. Flood, R.E. Marsh and H.B. Gray, *J. Am. Chem. Soc.*, 91 (1969) 6512.
- [121] T. Yoshida, T. Okana, D.L. Thorn, T.H. Tulip, S. Otsuka and J.A. Ibers, *J. Organomet. Chem.*, 181 (1979) 183.
- [122] P.W. Jolly, K. Jonas, C. Kruger and Y.-H. Tsay, *J. Organomet. Chem.*, 33 (1971) 109.
- [123] G.J. Leigh, R. Prieto-Alcon and J.R. Sanders, *J. Chem. Soc. Chem. Commun.*, (1991) 921.
- [124] K. Jonas, *Angew. Chem.*, 85 (1973) 1050; K. Jonas, D.J. Brauer, C. Kruger, P.J. Roberts and Y.-H. Tsay, *Angew. Chem.*, 85 (1973) 1051.
- [125] K. Jonas and C. Kruger, *Angew. Chem., Int. Ed. Engl.*, 19 (1980) 520.
- [126] G.P. Pez, P. Apgar and R.K. Crissey, *J. Am. Chem. Soc.*, 104 (1982) 482.
- [127] R. Duchateau, S. Gambarotta and C. Bensimon, *J. Am. Chem. Soc.*, 114 (1992) 482.
- [128] W.J. Evans, T.A. Ulibarri and J.W. Ziller, *J. Am. Chem. Soc.*, 110 (1988) 6877.
- [129] M.D. Fryzuk, T.S. Haddad and S.J. Rettig, *J. Am. Chem. Soc.*, 112 (1990) 8185.
- [130] J. Ho, R.J. Drake and D.W. Stephan, *J. Am. Chem. Soc.*, 115 (1993) 3792.
- [131] A.E. Shilov, *New J. Chem.*, 16 (1992) 1.
- [132] C.W. Bauschlicher, G.M. Pottersson and P.E.M. Siegbahn, *J. Chem. Phys.*, 87 (1987) 2129.
- [133] T.A. Bazhenova, R.M. Lobkovskaya, R.P. Shibaeva, A.E. Shilov, A.K. Shilova, M. Gruselle, G. LeNy and B. Tchoubar, *J. Organomet. Chem.*, 244 (1983) 265.
- [134] M. Aresta, P. Giannocaro, M. Rossi and A. Sacco, *Inorg. Chim. Acta*, 5 (1971) 115.
- [135] T.A. Bazhenova, L.M. Kachapina, A.E. Shilov, M.Yu. Antipin and Yu.T. Struchkov, *J. Organomet. Chem.*, 428 (1992) 107.
- [136] T.A. Bazhenova, A.V. Kulikov, A.F. Shestakov, A.E. Shilov, M.Yu. Antipin, K.A. Lyssenko, submitted to.
- [137] D. Coucouvanis, *Acc. Chem. Res.*, 24 (1991) 1, and reference cited therein.
- [138] S. Ciurli and R.H. Holm, *Inorg. Chem.* 28 (1989) 1685.
- [139] P.A. Eldredge, R.F. Bryan, E. Sinn and B.A. Averill, *J. Am. Chem. Soc.*, 110 (1988) 5573.